



The STAUFF Diagtronics programme provides components and services for monitoring and analysing hydraulic fluids in mobile and industrial hydraulic systems. The range includes analog stainless steel pressure gauges to high-quality, high-end laser particle counters.

A versatile range is essential for different customer needs. The innovative STAUFF Diagtronics programme addresses these decisive factors in the market and offers a wide range of state of the art products with the highest quality.

Competent and fast service is a matter of course in our company. All products undergo the relevant tests following international standards, and are subject to our in-house quality management in accordance with EN ISO 9001:2008.

Due to the extensive inventory, both customized special parts and special product combinations are available.

Please contact STAUFF for further details.





















[www.stauff.com](http://www.stauff.com)

## D Diagtronics

Index	D2
Pressure Gauges	D4
PPC Series	D13
Laser Particle Counters	D38
Sensors and Switches	D54

## Pressure Gauges (Analog and Digital)

## PPC Series

<b>Introduction</b>		<b>D4</b>	<b>Introduction</b>		<b>D13</b>
<b>Information on the Pressure Equipment Directive</b>		<b>D5</b>	<b>Overview</b>		<b>D14</b>
<b>Accessories for Pressure Gauges</b>		<b>D5</b>	<b>Functional Block Diagram</b>		<b>D15</b>
 <b>Pressure Gauge (Analog)</b>	SPG	<b>D6</b>	 <b>Hydraulic Tester</b>	PPC-04/2	<b>D16</b>
 <b>Pressure Gauge (Digital)</b>	SPG-DIGI	<b>D8</b>	 <b>Hydraulic Tester</b>	PPC-06/08-plus	<b>D17</b>
 <b>Pressure Gauge (Digital) Wireless</b>	SPG-DIGI-W	<b>D9</b>	 <b>Pressure Sensor</b>	PPC-04/12-PT/2	<b>D18</b>
 <b>Pressure Test Kit (Analog)</b>	SMB	<b>D10</b>	 <b>Temperature Sensor</b>	PPC-04/12-TS PPC-04/12-TSH	<b>D19</b>
 <b>Pressure Test Kit (Digital)</b>	SMB-DIGI	<b>D11</b>	 <b>Rotational Speed Sensor</b>	PPC-04/12-SDS-CAB	<b>D20</b>
<b>Accessories (Connection Adaptors)</b>		<b>D11</b>	 <b>Flow Turbine</b>	PPC-04/12-SFM	<b>D21</b>
			 <b>Gear Flow Meter</b>	PPC-04/12-SVC	<b>D22</b>
			 <b>Miscellaneous Measurements</b>		<b>D24</b>
			 <b>Cables / Adaptors / Accessories</b>		<b>D25</b>
			 <b>Complete Systems</b>	PPC-04/2 PPC-06/08-plus	<b>D26</b>
			<b>Hydraulic Test Equipment</b>		<b>D27</b>
			 <b>Hydraulic Tester</b>	PPC-Pad	<b>D28</b>
			 <b>Complete Systems</b>	PPC-Pad-SET	<b>D29</b>
			 <b>CAN Pressure Sensor</b>	PPC-CAN-PT	<b>D33</b>
			 <b>CAN Flow Turbine</b>	PPC-CAN-SFM	<b>D34</b>
			 <b>CAN Connection Cables</b>	PPC-CAN-CAB2 PPC-CAN-CAB-Y PPC-CAN-R	<b>D35</b>
			 <b>CAN Frequency Converter</b>	PPC-CAN-FR	<b>D35</b>
			<b>CAN Hydraulic Test Equipment</b>		<b>D37</b>

## Laser Particle Counters

	<b>Introduction</b>		<b>D38</b>
	<b>Overview</b>		<b>D38</b>
	<b>Features &amp; Options (General)</b>		<b>D39</b>
	<b>LasPaC II - Portable</b>	LasPaC II-P	<b>D40</b>
	<b>LasPaC II - Mobile</b>	LasPaC II-M	<b>D42</b>
	<b>LasPaC II - Inline</b>	LasPaC II-I	<b>D44</b>
	<b>Bottle Sampler Units</b>	Bottle Sampler 110 Bottle Sampler 250 Bottle Sampler 250-E	<b>D46</b>
	<b>Accessories</b>		<b>D47</b>
	<b>Laser Particle Monitor</b>	LPM-1	<b>D50</b>
	<b>Laser Particle Transducer</b>	LPT-1	<b>D51</b>
	<b>Laser Interface Module</b>	LIM	<b>D52</b>
	<b>Dynamic Application Valve</b>	DAV	<b>D52</b>
	<b>Oil Sampling Kit</b>	SFSK	<b>D53</b>

## Sensors and Switches

	<b>Introduction</b>		<b>D54</b>
	<b>Level-Temperature Switch</b>	SLTS	<b>D55</b>
	<b>Level-Temperature Switch Aluminium</b>	SLTSA	<b>D56</b>
	<b>Level-Temperature Switch Display</b>	SLTSD	<b>D57</b>
	<b>Pressure Switch</b>	SPW	<b>D58</b>
	<b>Pressure Switch</b>	SPW-SD	<b>D59</b>
	<b>Pressure Transmitters</b>	SPT	<b>D60</b>
	<b>Pressure Transmitters</b>	PT	<b>D64</b>
	<b>Pressure Switch and Transmitter</b>	SPWF	<b>D68</b>
	<b>Temperature Switch and Transmitter</b>	STWE	<b>D72</b>
	<b>Temperature Transmitter</b>	STC	<b>D74</b>
	<b>Temperature Switch</b>	STW	<b>D76</b>
	<b>Flowtell Inline Flow Meter</b>	SFF	<b>D77</b>
	<b>Flow Indicator</b>	SDM SDMK	<b>D78</b>
	<b>Flow Monitoring System</b>	SGF SGFE	<b>D80</b>

## Pressure Gauges



Measuring pressure on equipment is indispensable for monitoring and ensuring the smooth functioning and operating safety of these systems.

STAUFF offers a variety of simple pressure measuring devices for liquid and gaseous media. These pressure gauges can be used as both stationary or portable devices. STAUFF addresses the very extensive width of possible system pressures and the strict requirements for precision with a variety of pressure gauge types with different measuring ranges.

The glycerine filled gauge range is available with various connection ports to fit many different installation needs. The pressure gauges can be purchased alone or in a test kit. The kits can be supplied with gauges with different pressure ranges and adaptors to satisfy any requirement.

The analog pressure gauges are primarily designed for permanent installations. STAUFF also offers a digital line for analytical troubleshooting.

These digital pressure gauges are also available as a pressure test kit and also make it possible to perform the many different measurement tasks with the help of adapters and the measuring hose. An important advantage is the possibility to measure pressure peaks with the device, to save them short term and to display them in the display as MIN and MAX values.

A new development of this digital pressure gauge is the wireless data logger, which makes it possible to start pressure measurement series on a machine without a bothersome cable via radio signal and to transfer these to a PC or laptop. This wireless pressure gauge is one of the most affordable types of a wireless data logger.

## Information on the Pressure Equipment Directive (PED) 97/23/EC Pressure Equipment Directive (PED)

Our pressure gauges (SPG) conform to the European Standard EN 837-1 and are manufactured and tested according to appropriate requirements. Pressure gauges with a full scale value between 0,5 bar and 200 bar / 7.25 PSI and 2900 PSI come under „Good Engineering Practice“ and must not carry a CE mark (section 3, paragraph 3).

Pressure gauges (SPG) with a full scale value of less than 0,5 bar / 7.25 PSI and loose diaphragm sealings do not come under the PED and must not carry a CE mark. Our pressure gauges (SPG) with a full scale value of > 200 bar / 2900 PSI receive a CE mark according to the conformity procedure.

The CE mark is attached to the outside of the housing (type designation plate).  
We are not authorised to CE mark pressure gauges without a company name or a company logo.



### Pressure Gauges ▀ Accessories



**Single Station Gauge Isolator Valve**  
(see on page F78, Valves section)



**Multi Station Gauge Isolator Valve**  
(see on page F78, Valves section)



**Gauge Isolator Needle Valves**  
(see on page F79, see Valves section)



**Test Hoses - Gauge Adaptor**  
(see on page B36, STAUFF Test section)



**Gauge Adaptor**  
(see on page B11, STAUFF Test section)



**Direct Gauge Adaptor**  
(see on page B11, STAUFF Test section)



**Adjustable Gauge Fitting**  
(see on page B34, STAUFF Test section)

## Pressure Gauge (Analog) ▪ Type SPG



Pressure Gauge (Analog) Type SPG (Stem Mounting)



Pressure Gauge (Analog) Type SPG (Panel Mounting)

### Product Description

#### Area of Application

- Mechanical pressure measurement

#### Features

- Suitable for hydraulic oil and gaseous media compatible with copper based alloys
- Available in nominal sizes 63 and 100 mm / 2.5 and 4 in
- Thread form: for BSP (G1/4 and G1/2), NPT (1/4 NPT and 1/2 NPT), SAE (7/16–20 UNF)
- Stainless Steel (1.4301) housing
- Acrylic sight glass
- Glycerine filled
- Standard dual scales with pressure indication in bar and PSI
- U-bolt or flange mounting kit on request

Note: Please consult STAUFF before you use SPG with other media.

#### Options

- Protective rubber cap
- Additional scale readings including personalisation
- U-bolt and flange mounting kits are available separately as spare parts

#### Technical Data

- Pressure gauge according to EN 837-1
- Subject to technical modifications

#### Accuracies

SPG-063:	1.6 (± 1.6 % FS* as per EN 837-1)
SPG-100:	1.0 (± 1.0 % FS* as per EN 837-1)

#### Permissible Temperatures

- Ambient: -20 °C ... +60 °C / -4 °F ... +140 °F
- Media: max. +60 °C / max. +140 °F

#### Protection Ratings

- IP 65: for all manometer SPG 100 and SPG 063 > 25 bar / 362 PSI  
IP 65 protection rating: Dust tight and protected against water jets for all manometer SPG 063 ≤ 25 bar / 362 PSI due to pressure compensation opening
- IP 54: IP 54 protection rating: Dust protected and protected against splashing water

### Order Codes



#### ① Series and Type

Stainless Steel Pressure Gauge	<b>SPG</b>
--------------------------------	------------

#### ② Size

63 mm, with G1/4 or 1/4 NPT connection	<b>063</b>
100 mm, with G1/2 or 1/2 NPT connection	<b>100</b>

#### ③ Pressure Ranges

-1 ... 1,0 bar / -14.5 ... 21 PSI	<b>(-1)0001</b>
-1 ... 3 bar / -14.5 ... 43 PSI	<b>(-1)0003</b>
0 ... 10 bar / 0 ... 145 PSI	<b>0010</b>
0 ... 16 bar / 0 ... 232 PSI	<b>0016</b>
0 ... 25 bar / 0 ... 362 PSI	<b>0025</b>
0 ... 40 bar / 0 ... 580 PSI	<b>0040</b>
0 ... 60 bar / 0 ... 870 PSI	<b>0060</b>
0 ... 100 bar / 0 ... 1450 PSI	<b>0100</b>
0 ... 160 bar / 0 ... 2320 PSI	<b>0160</b>
0 ... 250 bar / 0 ... 3625 PSI	<b>0250</b>
0 ... 400 bar / 0 ... 5801 PSI	<b>0400</b>
0 ... 600 bar / 0 ... 8702 PSI	<b>0600</b>
0 ... 680 bar / 0 ... 9862 PSI	<b>0680</b>
0 ... 700 bar / 0 ... 10152 PSI	<b>0700</b>
0 ... 1000 bar / 0 ... 14503 PSI	<b>1000</b>

#### ④ Styles of Scales

bar / PSI (bar outside/PSI inside - standard option)	<b>01</b>
bar	<b>02</b>
PSI	<b>03</b>
PSI / bar (PSI outside/ bar inside)	<b>05</b>
kPa / PSI (kPa outside/ PSI inside)	<b>10</b>

Note: Others on request.

#### ⑤ Adaption

Stem mounting	<b>S</b>
Panel mounting	<b>P</b>

#### ⑥ Process Connection

G1/4 (only SPG 063)	<b>B04</b>
G1/2 (only SPG 100)	<b>B08</b>
1/4 NPT (only SPG 063)	<b>N04</b>
1/2 NPT (only SPG 100)	<b>N08</b>
7/16–20 UNF (only SPG 063)	<b>U04</b>

Note: Others on request.

#### ⑦ Accessories (for Panel Mount only)

No accessory	<b>(none)</b>
U-bolt assembly	<b>U</b>
Front flange assembly	<b>F</b>
Rear flange assembly	<b>R</b>
U-bolt and front flange assembly	<b>UF</b>

#### ⑦ Accessories (for Stem Mount only)

Protective rubber cap	<b>G</b>
-----------------------	----------

For further information on this product, please see page B34, STAUFF Test section.

## Pressure Gauge (Analog) ▪ Type SPG

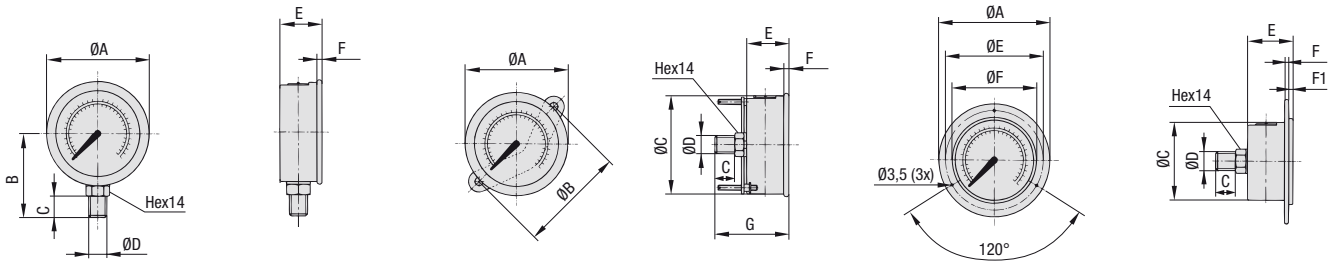

SPG 063 ... S ...

SPG 063 ... P ... U

SPG 063 ... P ... F

## Dimensions SPG 063

Version Pressure Gauge	Dimension (mm/in)											
	ØA	ØB	ØC	ØD	ØE	ØF	B	C	E	F	F1	G
SPG-063	69	-	-	G1/4	-	-	54	15	32	6,5	-	-
	2.72	-	-	1/4 NPT	-	-	2.13	.59	1.26	.26	-	-
				7/16-20 UNF								
SPG-063 ... U	69	72	62	G1/4	-	-	-	15	32	6,5	-	56
	2.72	2.83	2.44	1/4 NPT	-	-	-	.59	1.26	.26	-	2.20
				7/16-20 UNF								
SPG-063 ... F	85	-	62	G1/4	75	68	-	15	32	2	2	-
	3.35	-	2.44	1/4 NPT	2.95	2.68	-	.59	1.26	.008	.008	-
				7/16-20 UNF								

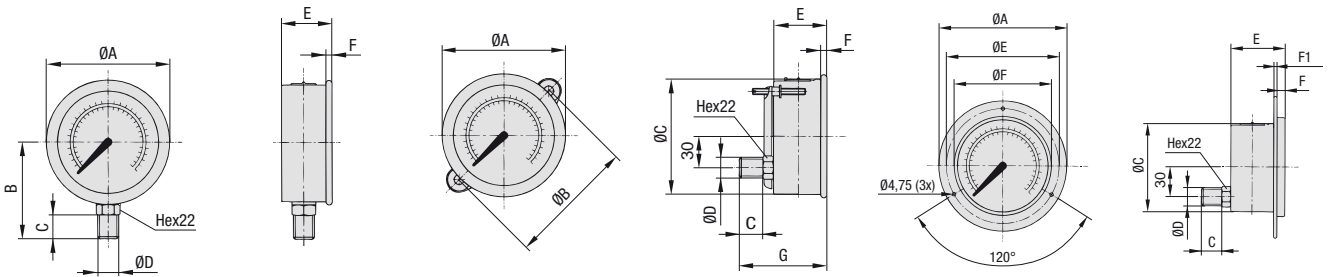

SPG 100 ... S ...

SPG 100 ... P ... U

SPG 100 ... P ... F

## Dimensions SPG 100

Version Pressure Gauge	Dimension (mm/in)											
	ØA	ØB	ØC	ØD	ØE	ØF	B	C	E	F	F1	G
SPG-100	107	-	-	G1/2	-	-	87	23	48	8	-	-
	4.21	-	-	1/2 NPT	-	-	3.43	.91	1.89	.31	-	-
SPG-100 ... U	107	107	100	G1/2	-	-	-	23	48	8	-	81,5
	4.21	4.21	3.94	1/2 NPT	-	-	-	.91	1.89	.31	-	3.21
SPG-100 ... F	132	-	100	G1/2	116	107	-	23	48	8	1,25	-
	5.20	-	3.94	1/2 NPT	4.57	4.21	-	.91	1.89	.31	.05	-

\* FS = Full Scale

Dimensional drawings: All dimensions in mm (in).

## Pressure Gauge (Digital) ▪ Type SPG-DIGI



### Product Description

The SPG-DIGI Digital Pressure Gauges are intended to measure and display pressures in hydraulic systems, particularly for oils, lubricants and water. They can display the current measured values, as well as minimum and maximum values, with an accuracy of 0,5 % of full scale.

The SPG-DIGI Digital Pressure Gauges are available individually, or as part of a complete pressure test kit. They are very sturdy, reliable, easy to use and come with the CE mark (evidence of conformity compliance).

### Features

- Bar graph display (drag indicator)
- Background lighting
- Zero correction
- Battery charge display

### Order Codes



#### ① Series

Pressure Gauge **SPG**

#### ② Type

Digital pressure measurement and display **DIGI**

#### ③ Pressure Ranges

-1 ... 16 bar / -14.5 ... 232 PSI	<b>B0016</b>
0 ... 100 bar / 0 ... 1450 PSI	<b>B0100</b>
0 ... 400 bar / 0 ... 5801 PSI	<b>B0400</b>
0 ... 600 bar / 0 ... 8702 PSI	<b>B0600</b>

#### ④ Process Connection

G1/4	<b>B</b>
7/16–20 UNF	<b>U</b>

#### ⑤ Calibration

Without calibration certificate	<b>(none)</b>
With calibration certificate	<b>CAL</b>

### Pressure Ranges

Version	Pressure Range (bar/PSI)	Maximum Pressure (bar/PSI)	Burst Pressure (bar/PSI)
<b>B0016</b>	-1 ... 16	40	50
	-14.5 ... 232	580	725
<b>B0100</b>	0 ... 100	200	800
	0 ... 1450	2900	11603
<b>B0400</b>	0 ... 400	800	1700
	0 ... 5801	11603	24656
<b>B0600</b>	0 ... 600	1200	2200
	0 ... 8702	17404	31908

### Technical Data

#### Materials

- Housing made of die-cast Zinc with TPE rubber protective covering
- Adaptor made of Steel, zinc-nickel coated
- Gaskets: NBR (Buna-N®) or EPDM upon request

#### Dimensions and Weight

- Diameter: 79 mm / 3.11 in
- Depth: 33 mm / 1.30 in
- Weight: 540 g / 1.19 lbs

#### Display

- Text display 4 1/2-digit
- Size: 50 x 34 mm / 1.97 x 1.34 in
- Actual value display: 15 mm / .59 in
- MIN-/MAX or FS\* display: 8 mm / .31 in
- Units: bar, PSI, Mpa, kPa, mbar
- Peak pressure measurement with 10 ms sampling rate
- Lighted measured value display

#### Accuracy

- ±0,25 % FS\* typ. / ±0,5 % FS\* max.
- Resolution: 4096 steps

#### Permissible Temperatures

- Ambient: -10 °C ... +50 °C / +14 °F ... +122 °F
- Media: -20 °C ... +80 °C / -4 °F ... +176 °F
- Storage: -20 °C ... +60 °C / -4 °F ... +140 °F

- Relative humidity: < 85 %
- Battery life: max. 1500 hours (operating without lighting, 2 x 1,5 V DC AA (LR6-AA) Alkaline Mignon)

#### Process Connections

- G1/4 or 7/16–20 UNF made of 1.4404 Stainless Steel

- Vibration: IEC 60068-2-6 / 10 ... 500 Hz / 5 g
- Shock: IEC 60068-2-27 / 11 ms / 25 g
- Load cycles (10<sup>6</sup>): 100

#### Protection Rating

- IP 67 protection rating: Dust tight and protected against powerful water jets; even immersion (up to 1 m / 3.28 ft) in water is possible under defined conditions of pressure and time



## Pressure Gauge (Digital) Wireless - Type SPG-DIGI-W



PC adaptor SPG-DIGI-W-PC only included in the SMB-DIGI-W Pressure Test Kit

## Order Codes



## ① Series

Pressure Gauge **SPG**

## ② Type

Digital pressure measurement and display (wireless) **DIGI-W**

## ③ Pressure Ranges

-1 ... 16 bar / -14.5 ... 232 PSI	<b>0016</b>
0 ... 100 bar / 0 ... 1450 PSI	<b>0100</b>
0 ... 400 bar / 0 ... 5801 PSI	<b>0400</b>
0 ... 600 bar / 0 ... 8702 PSI	<b>0600</b>

## ④ Process Connection

G1/4 **B**  
7/16-20 UNF **U**

## ⑤ Calibration

Without calibration certificate **(none)**  
With calibration certificate **CAL**

## Pressure Ranges

Version	Pressure Range ( <sup>bar</sup> / <sub>PSI</sub> )	Maximum Pressure ( <sup>bar</sup> / <sub>PSI</sub> )	Burst Pressure ( <sup>bar</sup> / <sub>PSI</sub> )
B0016	-1 ... 16	40	50
	-14.5 ... 232	580	725
B0100	0 ... 100	200	800
	0 ... 1450	2900	11603
B0400	0 ... 400	800	1700
	0 ... 5801	11603	24656
B0600	0 ... 600	1200	2200
	0 ... 8702	17404	31908

## Technical Data

## Materials

- Housing made of die-cast Zinc with TPE rubber protective covering
- Adaptor made of Steel, zinc-nickel coated
- Gaskets: NBR (Buna-N®)  
FPM (Viton®) or EPDM upon request

## Dimensions and Weight

- Diameter: 79 mm / 3,11 in
- Depth: 33 mm / 1,30 in
- Weight: 540 g / 1,19 lbs

## Display

- Text display 4 1/2-digit
- Size: 50 x 34 mm / 1.97 x 1.34 in
- Actual value display: 15 mm / .59 in
- MIN-/MAX or FS\* display: 8 mm / .31 in
- Units: bar, PSI, Mpa, kPa, mbar
- Peak pressure measurement with 10 ms sampling rate
- Lighted measured value display

## Accuracy

- ±0,25 % FS\* typ. / ±0,5 % FS\* max.
- Resolution: 4096 step

\* FS = Full Scale

## Permissible Temperatures

- Ambient: -10 °C ... +50 °C / +14 °F ... +122 °F
- Media: -20 °C ... +80 °C / -4 °F ... +176 °F
- Storage: -20 °C ... +60 °C / -4 °F ... +140 °F

- Relative humidity: < 85 %
- Battery life: max. 800 hours  
(operating without lighting, 2 x 1,5 V DC AA (LR6-AA) Alkaline Mignon)

## Process Connections

- G1/4 or 7/16-20 UNF made of 1.4404 Stainless Steel

- Vibration: IEC 60068-2-6 / 10 ... 500 Hz / 5 g
- Shock: IEC 60068-2-27 / 11 ms / 25 g
- Load cycles (10<sup>6</sup>): 100

## PC Functions

- Read-out data from measured data memory via a radio interface (2,4 GHz)
- Measuring over a distance of max. 50 m / 164.04 ft
- Remote configuration of the gauges

## Product Description

In addition to the existing STAUFF product range in the field of digital pressure measuring, the new Wireless Digital Pressure Gauge (SPG-DIGI-W) is now available, allowing a most precise measurement and wireless transmission of values to a PC or notebook.

With its compact design and the ease of operation, the SPG-DIGI-W is actually a single channel wireless data logger. With just a single PC adaptor, you can simultaneously transmit measured values of up to 16 digital pressure gauges over a distance of max. 50 m / 164.04 ft to your computer.

The configuration of the gauges and the inspection of your machinery and equipment can be easily accomplished from your desk, thus allowing the direct evaluation and storage of the measured values. Please note that measured values cannot be displayed in real time.

## Features

- Bar graph display (drag indicator)
- Background lighting
- Zero correction
- Battery charge display
- Wireless data logging

## Memory Functions

- 5000 measurement values (MAX pressure peaks)
- Setup of storage interval
- Time based recording
- Pressure spike monitoring

## Protection Rating

- IP 67 protection rating: Dust tight and protected against powerful water jets; even immersion (up to 1 m / 3.28 ft) in water is possible under defined conditions of pressure and time

**Pressure Test Kit (Analog) ▀ Type SMB-20/-15**



**Product Description**

In addition to the individual SPG gauges, the STAUFF Pressure Gauges are also available as part of a pressure test kit.

The SMB Pressure Test Kits are assembled in various versions, in accordance with customer wishes. All pressure test kits are supplied in a handy case with custom-designed foam inserts.

**Components**

**Standard Option SMB-20-1-xxx-C6F**

- 1x Test hose (2000 mm length): SMS-20-2000-A-C6F
- 1x Pressure gauge Ø 63 mm: SPG 063-xxx-...
- 1x Gauge adaptor G1/4: SMA20-G1/4-P-OR-C6F
- 1x Direct gauge adaptor G1/4: SMD20-G1/4P-OR-C6F
- 1x Test coupling G1/4: SMK20-G1/4-PC-C6F
- 1x Test coupling M10 x 1: SMK20-M10x1-PA-C6F
- 1x Thread adaptor G3/8: SRS20-G3/8-B-C6F
- 1x Thread adaptor G1/2: SRS20-G1/2-B-C6F

**Standard Option SMB-20-2-xxx/xxx-C6F**

- 1x Test hose (2000 mm length): SMS-20-2000-A-C6F
- 2x Pressure gauge Ø 63 mm: SPG 063-xxx-...
- 1x Gauge adaptor G1/4: SMA20-G1/4-P-OR-C6F
- 1x Direct gauge adaptor G1/4: SMD20-G1/4P-OR-C6F
- 1x Test coupling G1/4: SMK20-G1/4-PC-C6F
- 1x Test coupling M10 x 1: SMK20-M10x1-PA-C6F
- 1x Thread adaptor G3/8: SRS20-G3/8-B-C6F
- 1x Thread adaptor G1/2: SRS20-G1/2-B-C6F

**Standard Option SMB-20-3-xxx/xxx/xxx-C6F**

- 2x Test hose (2000 mm length): SMS-20-2000-A-C6F
- 3x Pressure gauge Ø 63 mm: SPG 063-xxx-...
- 1x Gauge adaptor G1/4: SMA20-G1/4-P-OR-C6F
- 2x Direct gauge adaptor G1/4: SMD20-G1/4P-OR-C6F
- 3x Test coupling G1/4: SMK20-G1/4-PC-C6F
- 3x Test coupling M10 x 1: SMK20-M10x1-PA-C6F
- 1x Thread adaptor G3/8: SRS20-G3/8-B-C6F
- 1x Thread adaptor G1/2: SRS20-G1/2-B-C6F

**Standard Option SMB-20/100-1-xxx-C6F**

- 1x Test hose (2000 mm length): SMS-20-2000-A-C6F
- 1x Pressure gauge Ø 100 mm: SPG 100-xxx-...
- 1x Gauge adaptor G1/2: SMA20-G1/2-P-OR-C6F
- 1x Direct gauge adaptor G1/2: SMD20-G1/2-P-OR-C6F
- 1x Test coupling G1/4: SMK20-G1/4-PC-C6F
- 1x Test coupling M10 x 1: SMK20-M10x1-PA-C6F
- 1x Thread adaptor G3/8: SRS20-G3/8-B-C6F
- 1x Thread adaptor G1/2: SRS20-G1/2-B-C6F

Note: All test kits also available as SMB-15 version.

**Order Codes**



**① Series**

Pressure Test Kit	<b>SMB</b>
-------------------	------------

**② Types**

Test 20	<b>20</b>
Test 15	<b>15</b>

**③ Number of Pressure Gauges**

1 pressure gauge SPG 063 mm	<b>1</b>
2 pressure gauges SPG 063 mm	<b>2</b>
3 pressure gauges SPG 063 mm	<b>3</b>
1 pressure gauge SPG 100 mm	<b>/100-1</b>

**④ Pressure Ranges**

-1 ... 3 bar / -14.5 ... 43 PSI	<b>(-1)0003</b>
0 ... 10 bar / 0 ... 145 PSI	<b>010</b>
0 ... 16 bar / 0 ... 232 PSI	<b>016</b>
0 ... 25 bar / 0 ... 362 PSI	<b>025</b>
0 ... 40 bar / 0 ... 580 PSI	<b>040</b>
0 ... 60 bar / 0 ... 870 PSI	<b>060</b>
0 ... 100 bar / 0 ... 1450 PSI	<b>100</b>
0 ... 160 bar / 0 ... 2320 PSI	<b>160</b>
0 ... 250 bar / 0 ... 3625 PSI	<b>250</b>
0 ... 400 bar / 0 ... 5801 PSI	<b>400</b>

Note: Please indicate pressure ranges in bar.  
 For one pressure gauge please replace xxx.  
 For two pressure gauges please replace xxx/xxx.  
 For three pressure gauges please replace xxx/xxx/xxx.

**⑤ Material Surface**

Steel, zinc/nickel plated	<b>C6F</b>
---------------------------	------------

For further information on this product please see page B35, STAUFF Test section.

## Pressure Test Kit (Digital) - Type SMB-DIGI /-W



Pressure Test Kit (Digital) Type SMB-DIGI-W



Pressure Test Kit (Digital) Type SMB-DIGI

## Order Codes

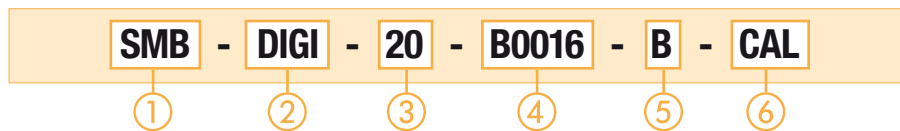

## ① Series

 Pressure Test Kit **SMB**

## ② Types

 SPG-DIGI digital pressure gauge **DIGI**  
 SPG-DIGI digital pressure gauge (wireless) **DIGI-W**

## ③ Adaptor Version

 Adapts to STAUFF Test 20 (M16 x 2) **20**  
 Adapts to STAUFF Test 12 (S12,65 x 1,5) **12**

## ④ Pressure Ranges

-1 ... 16 bar / -14.5 ... 232 PSI	<b>B0016</b>
0 ... 100 bar / 0 ... 1450 PSI	<b>B0100</b>
0 ... 400 bar / 0 ... 5801 PSI	<b>B0400</b>
0 ... 600 bar / 0 ... 8702 PSI	<b>B0600</b>

## ⑤ Process Connection

G1/4	<b>B</b>
7/16-20 UNF	<b>U</b>

## ⑥ Calibration

Without calibration certificate	<b>(none)</b>
With calibration certificate	<b>CAL</b>

## Pressure Ranges

Version	Pressure Range (bar/PSI)	Maximum Pressure (bar/PSI)	Burst Pressure (bar/PSI)
<b>B0016</b>	-1 ... 16	40	50
	-14.5 ... 232	580	725
<b>B0100</b>	0 ... 100	200	800
	0 ... 1450	2900	11603
<b>B0400</b>	0 ... 400	800	1700
	0 ... 5801	11603	24656
<b>B0600</b>	0 ... 600	1200	2200
	0 ... 8702	17404	31908

## Product Description

In addition to the individual SPG-DIGI devices, the STAUFF Digital Pressure Gauges are also available as part of a pressure test kit.

The SMB-DIGI pressure test kits are assembled in various versions, in accordance with customer wishes. All pressure test kits are supplied in a handy case with custom-designed foam inserts.

Along with the SPG-DIGI-W itself, the pressure test kits always contain a PC adaptor with USB connection cable (1,5 m / 4.92 ft).

## Components

**Standard Option SPG-DIGI**

- SPG-DIGI digital pressure gauge
- SDA adaptor (G1/4 to M16 x 2 or S12,65 x 1,5)
- SSV20 or SSV12 hose connector
- SMK20-G1/4-PC-C6F or SKK12-G1/4-PC-C6F test point
- SMK20-M10x1-PA-C6F or SKK12-M10x1-PA-C6F test point
- SRS-G3/8-B-C6F reducing thread adaptor
- SRS-G1/2-B-C6F reducing thread adaptor
- SMS test hose (2 m / 6.56 ft), M16 x 2 or S12,65 x 1,5 connection, pressure-resistant to 600 bar (8702 PSI)
- Operating instructions (multilingual) on CD
- Dust cloth

**Standard Option SPG-DIGI-W**

- SPG-DIGI-W digital pressure gauge
- PC adaptor SPG-DIGI-W-PC with USB connection
- SDA adaptor (G1/4 to M16 x 2 or S12,65 x 1,5)
- SSV20 or SSV12 hose connector
- SMS test hose (2 m / 6.56 ft), M16 x 2 or S12,65 x 1,5 connection, pressure-resistant to 600 bar (8702 PSI)
- Operating instructions and software (multilingual) on CD
- Dust cloth

## Accessories (Connection Adaptors)

Adaptor	Adaption from	to Dimension G
SDA20-G1/4-C6F	G1/4	M16 x 2
SDA15-G1/4-C6F	G1/4	M16 x 1,5
SDA12-G1/4-C6F	G1/4	S12,65 x 1,5
SAD20/15-P-C6F	M16 x 2	M16 x 1,5
SAD20/12-P-C6F	M16 x 2	S12,65 x 1,5
SAD20/10-P-C6F	M16 x 2	Plug-in system

A large number of adaptors are available to connect STAUFF SPG-DIGI and SPG-DIGI-W pressure gauges to other test points and testers. Other adaptors are available.

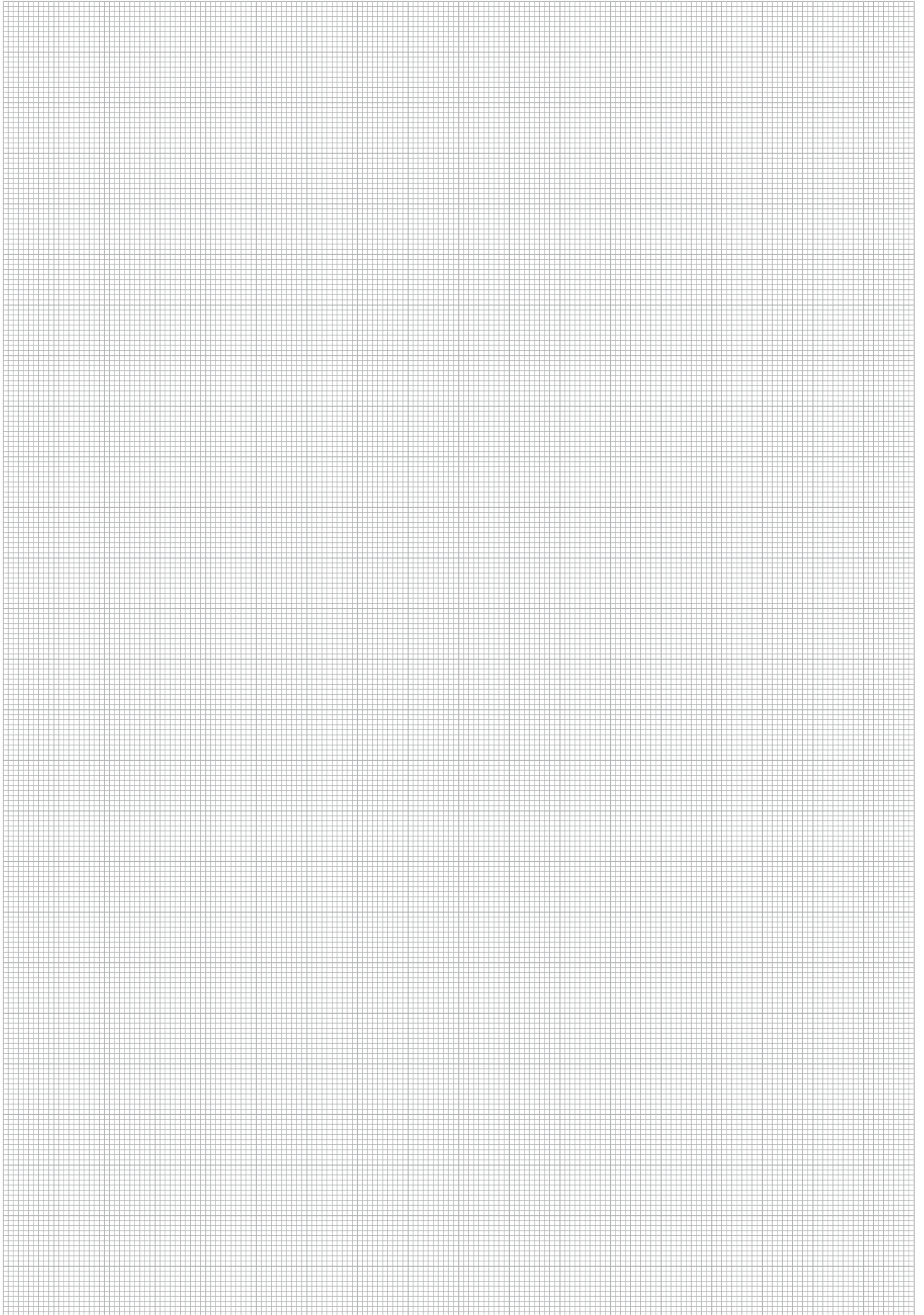

## Hydraulic Testers ■ PPC Series



The STAUFF measuring and test equipment of the PPC series are perfectly suited for measuring all relevant parameters in fluid power systems, including pressure, differential pressure, temperature, flow and rotational speed. Depending on the type, they allow evaluation, storage and further processing in PCs or notebooks. They have been especially developed for the growing needs of system monitoring, troubleshooting and determining measured values in hydraulic and pneumatic systems. The application areas are broad:

- Industrial hydraulics
- Mobile, agricultural and forestry hydraulics
- Marine and offshore hydraulics
- Chemical and petrochemical industries
- Energy and air conditioning industries
- Heating and sanitary industries

The hydraulic testers of the PPC-04/2 series are distinguished by simple operation using eight buttons. They are suitable for connecting two sensors simultaneously and show the measured values as numbers on their two-line display. The hydraulic testers of the PPC-06/08-plus series depending upon the type, provide the potential of connecting 3 or 4 sensors. They have internal memory and can not only output the measured values as numbers, they can also display them as graphs on your PC.

The PPC-06/08 series has been fully revised and replaced by the PPC-06/08-plus series. New features include the addition of a USB interface, a larger data memory, and also considerably longer operating times with the rechargeable battery. They work with the same sensor connections as the PPC-06/08/12 series. That's why connecting the PPC-06/08-plus unit with the sensors is still pretty easy.

A further development within the PPC series is the new PPC Pad. It is a result of the new demands on the hydraulic technician, who is faced with ever more complex systems. The new device increasingly blends together the areas of hydraulics and electronics. With the new CAN bus system it is ideally suited to the growing requirements in the near future. The clear and large colour display provides a good view of the measured values.

All hydraulic testers of the PPC series and their corresponding sensors are also available in a calibrated version. A separate calibration certificate is supplied with each tester. Subsequent calibration of the hydraulic testers and sensors is also possible. The optional and subsequent calibration must be ordered using a separate ordering code.

Hydraulic Testers ■ PPC Series

Hydraulic Testers						
Options	PPC-04-B/2	PPC-04-A/2	PPC-04-AP/2	PPC-06-plus	PPC-08-plus	PPC-Pad

Rechargeable Battery	–	●	●	●	●	●
Battery Operation	●	–	–	–	–	–
Number of Sensor Inputs	2	2	2	3	4	max. 6+CAN
PC Interface	–	–	RS-232	USB	USB	USB / Ethernet
Online Function	–	–	●	●	●	●
Internal Memory	–	–	–	●	●	●
Programming of Automatic Measuring Tasks	–	–	–	●	●	●
Internal Trigger Function	–	–	–	●	●	●
Data Display	●	●	●	●	●	●
Graphic Display	–	–	–	●	●	●
Display Lightning	–	–	–	●	●	●
Curve Printout on Display	–	–	–	–	–	●
PC Software Kit	–	–	○	●	●	●

Pressure Measurement	●	●	●	●	●	●
Temperature Measurement	●	●	●	●	●	●
Flow Measurement	●	●	●	●	●	●
Rotational Speed Measurement	●	●	●	●	●	●
Frequency Measurement	–	–	–	●	●	●
External Trigger Function	–	–	–	●	●	●
Third-Party Sensors	–	–	–	●	●	●
Current / Voltage Adaptor	–	–	–	●	●	●
STAUFF-CAN-Sensor	–	–	–	–	–	●

○ = Optional, ● = Standard, – = not available

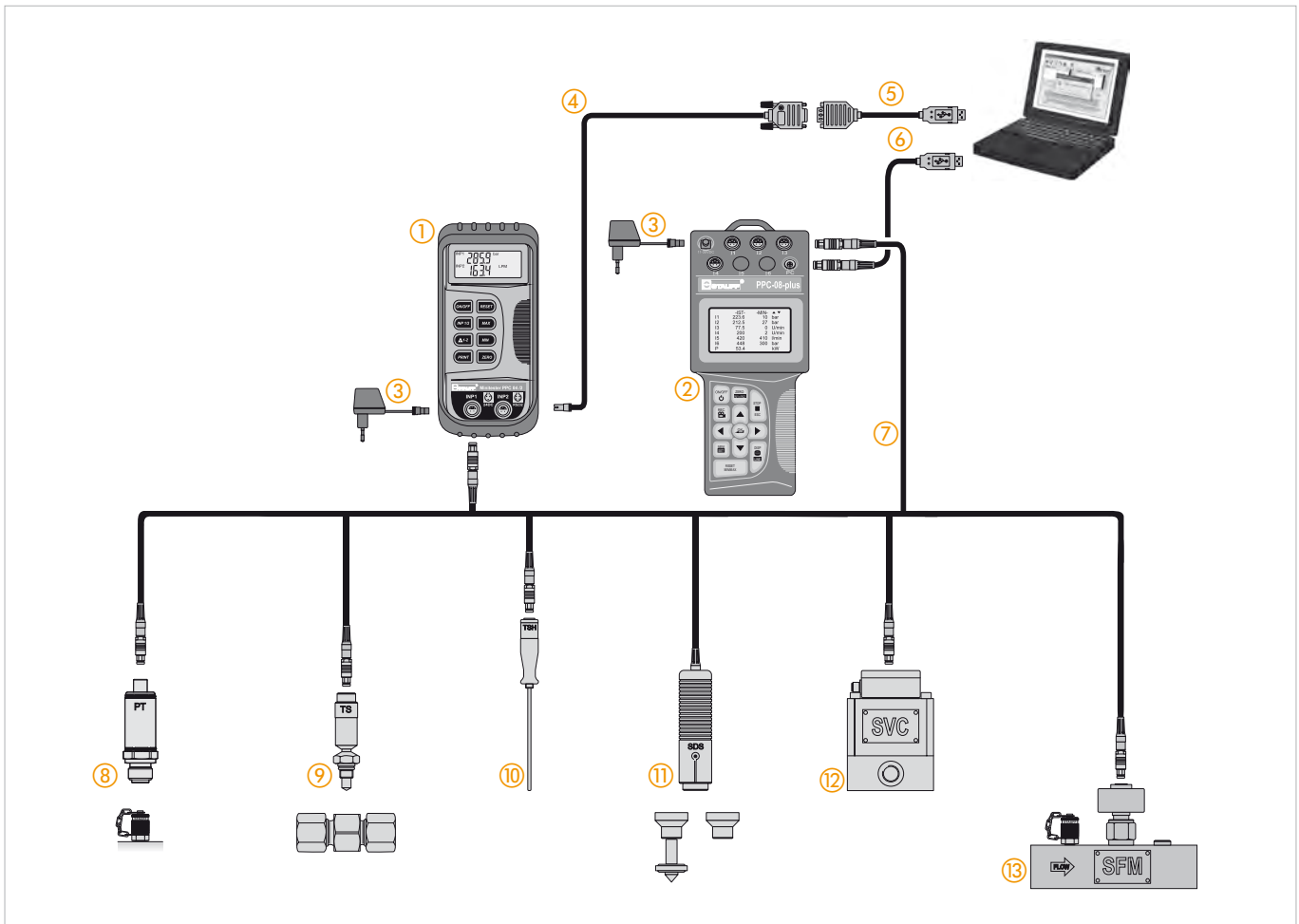

- ① PPC-04/2 hydraulic tester  
A maximum of 2 connecting cables for sensors can be connected at the same time.
- ② PPC-06-plus or PPC-08-plus hydraulic tester  
A maximum of 3 or 4 connecting cables for sensors can be connected at the same time.
- ③ PPC-04/12-110/230V AC power supply unit (not for PPC-04-B/2)
- ④ PC connecting cable as a component of the PC-SET-04-SW-CAB
- ⑤ PPC-04/12-RS232-to-USB-CAB PC adaptor cable
- ⑥ PPC connecting cable as a component of the PC-SET-06/08-plus-SW-CAB (USB) PC set
- ⑦ PPC-04/12-CAB3 (3 m / 9.84 ft) 5-pin connecting cable, optionally with PPC-04/12-CAB5-EXT (5 m / 16.40 ft) extension cable
- ⑧ PPC-04/12-PT-/2 pressure sensor
- ⑨ PPC-04/12-TS screw-in temperature sensor with M10 x 1 connection, optionally with SGV-16S-G-C6F straight threaded pipe joint
- ⑩ PPC-04/12-TSH manual temperature sensor
- ⑪ PPC-04/12-SDS-CAB rotational speed sensor with integrated connecting cable, optionally with PPC-04/12-SKA-Contact contact adaptor or PPC-04/12-SKA-Focus focusing adaptor
- ⑫ PPC-04/12-SVC flow meter with integrated signal converter
- ⑬ PPC-04/12-SFM flow meter with integrated signal converter, for connecting pressure and temperature sensor

## Calibration Certificate



All units are available as calibrated version.

**Hydraulic Tester - Type PPC-04/2**



Two separate test inputs

**Product Description**

The PPC-04/2 Hydraulic Testers were designed for initial start-up, service and maintenance work on fluid power systems. Hydraulic systems are becoming more and more accurate and thus require quick, simple checking of the hydraulic key data.

- Two-line display
- 5-pin sensor input
- "ZERO" function

The PPC-04/2 can be operated simply, using eight buttons. Just like all testers of the PPC series, it is superbly suited for measuring operating pressure, peak pressure, differential pressure, media temperature, flow and rotational speed. The tester has two separate test inputs that automatically detect the connected sensors. The new two-line display now allows simultaneous display of both sensor inputs. The measuring unit can be selected during power-on at the touch of a button.

The ruggedness of the tester continues in the rubber protective coating that protects the actual tester against impacts. Voltage is supplied either by a commercially available 9 V battery (PPC-04-B/2) or from an integrated rechargeable battery (PPC-04-A/2 and PPC-04-AP/2).

Measurements taken over a lengthy period of time are possible, using a power supply (not for the PPC-04-B/2) which charges the rechargeable battery at the same time. The data printout is used for the documentation requirement within the scope of ISO 9001 and is compliant with CE.

The PPC-04/2 can be connected to a PC via an RS-232 interface through a data output (only for the PPC-04-AP/2). Connection to a USB port is possible using an optional adaptor. The PPC-04/2 software that can be ordered separately is compatible with popular PC operating systems such as Windows 95®, Windows 98®, Windows 2000®, Windows NT®, Windows XP®, Windows Vista® and Windows 7®.

It is also possible to connect the pressure sensors under load, with the equipment switched on. The temperature and volume flow sensors are to be installed in the pipelines. The rotational speed sensor is a non-contacting sensor and uses an optical mark on the rotating parts. Measuring the differential pressure requires two pressure sensors with identical measuring ranges.

The units are also available as a complete set. Please see page D26.

Note: The hydraulic tester does not have an internal memory for measured values (except for the temporary MIN-/MAX memory)!

**Technical Data**

**Materials**

- Housing made of ABS in a rubber protective case with carrying strap and stand

**Dimensions and Weight**

- L/W/H: 145 x 70 x 40 mm / 5.71 x 2.76 x 1.57 in
- Weight: 330 g / .73 lbs

**Measurements / Display**

- Pressure: in bar and PSI
- Temperature: in °C and °F
- Volume flow: in l/min and US GPM
- Rotational speed: in RPM
- Two-line LCD display (4-digit)
- Numeral height: 8 mm / .32 in
- Data output for connection to notebook or PC (PPC-04-AP/2 only)

**Power Supply**

- Power supply unit 110/230 V AC (50/60 Hz) (PPC-04-A/2 and PPC-04-AP/2)
- Internal rechargeable battery 9 V / 110 mAh
- Operating time with the rechargeable battery: approx. 5 hours

**Sensor Inputs (5-Pin)**

- Automatic sensor detection
- Input signal: 0 ... 3 V DC (R = 470 kΩ)
- Sampling rate: 2 ms
- Accuracy: < ±0,25 % FS\*

**Data Output**

- RS-232 interface
- Optionally with RS-232 adaptor to USB

**Permissible Temperatures**

- Ambient: 0 °C ... +50 °C / +32 °F ... +122 °F
- Storage: -20 °C ... +60 °C / -4 °F ... +140 °F

- Relative humidity: < 85 %
- CE certified

**Protection Rating**

- IP 54 protection rating: Dust protected and protected against splashing water

**Order Codes**



① Series and Type

Hydraulic Tester	PPC-04
------------------	--------

② Version

With battery	B/2
With rechargeable battery	A/2
With rechargeably battery and data output	AP/2

**Software**

An optional PC set is available for the PPC-04-AP/2, for connecting it to a PC or a notebook. This set contains both a PC adaptor (RS-232 connection, length: 2 m / 6.56 ft) and the corresponding PC software. The measured values can then easily be processed as a data series or a chart using Microsoft Excel®.

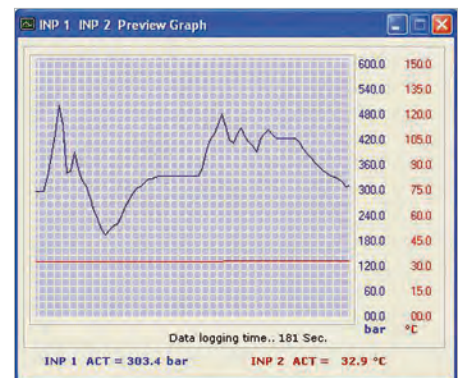



## Hydraulic Tester ■ Type PPC-06/08-plus



PPC-08-plus with 4 sensor inputs



### Order Codes

**PPC - 06-plus**

①

②

#### ① Series and Type

Hydraulic Tester

**PPC**

#### ② Version

With 3 sensor inputs

**06-plus**

With 4 sensor inputs

**08-plus**

Version	No. Sensor Inputs	Integrated Data Memory for Measuring Value Points	Storable Curves
06-plus	3	1000000 Points	240000 Points
08-plus	4	1000000 Points	240000 Points

### Software

A PC set, consisting of a USB connecting lead, Length 1,5 m / 4.9 ft and the corresponding PC software, is included as standard with every PPC-06-plus and PPC-08-plus.

The measured data and curves can easily be processed using Microsoft Excel® with the software.

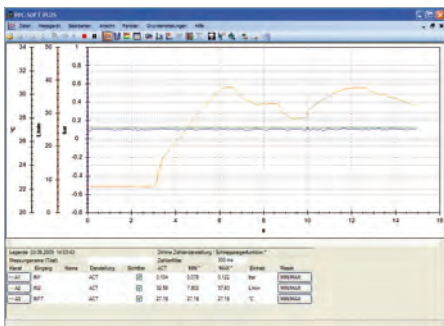

### Technical Data

#### Material

- Housing made of fibreglass-reinforced PA

#### Dimensions and Weight

- L/W/H: 235 x 106 x 53 mm / 9.25 x 4.17 x 2.09 in
- Weight: 530 g / 1.17 lbs

#### Measurements / Display

- Pressure: in bar and PSI
- Temperature: in °C and °F
- Volume flow: in l/min and US GPM
- Rotational speed: in RPM
- Digital LCD display: 128 x 64 Pixel
- Visible area: 72 x 40 mm / 2.84 x 1.58 in
- Automatic numeral height adjustment
- Numeral height: 6 mm / .24 in with eight-line display
- Data output for connection to notebook or PC
- 12-key membrane keyboard
- Electromagnetic compatibility (EMC):  
Emitted interference: DIN EN 50081, Part 1  
Interference immunity: DIN EN 50082, Part 2
- Auto Power Off (after 20 minutes)
- Battery charge display

#### Measured Data Memory

- Variable storage interval (1 ms ... 10 s) or variable storage time (2 s ... 100 h)
- Manual and automatic triggering

#### Power Supply

- Power supply unit: 110/230 V AC (50/60 Hz)
- Rechargeable battery charging circuit
- Internal nickel-metal hybrid rechargeable battery 7,2 V / 700 mAh
- Operating time with the rechargeable battery: approx. 8 hours

#### Sensor Inputs (5-Pin)

- Automatic sensor detection
- Input signal: 0 ... 3 V DC (R = 470 kΩ)
- Frequency range: 0,5 Hz ... 30 kHz
- Sampling rate: 1 ms
- Accuracy: < ±0,25 % FS\*

#### Data Output

- Integrated USB port (USB 2.0)
- Online data transmission to a PC  
Speed individually eligible (5 ms ... 60 s)

#### Permissible Temperatures

- Ambient: 0 °C ... +50 °C / +32 °F ... +122 °F
- Storage: -25 °C ... +60 °C / -13 °F ... +140 °F
- Temperature error: < 0,02 % / °C

- Relative humidity: < 80 %
- CE certified
- IP 54 protection rating: Dust protected and protected against splashing water

### Product Description

The PPC-06/08-plus Hydraulic Testers have been especially developed for the growing demands of system monitoring and troubleshooting in hydraulic and pneumatic systems.

The PPC-06/08 series has been fully revised and replaced by the PPC-06/08-plus series. New features include the addition of a USB interface, a larger data memory, and also considerably longer operating times with the rechargeable battery. They work with the same sensor connections as the old PPC-06/08/12 series.

- Automatic sensor detection
- Larger data memory
- Possible to record MIN-/MAX values over long periods
- Internal trigger function
- External trigger function
- Online data transmission
- Display lighting
- Programming by PC and notebook
- USB interface

The ergonomically designed housing and the LCD display, which sets automatically to the appropriate line size, now allows problem free use even under difficult environmental conditions.

The individual PPC-06-plus and PPC-08-plus testers differ in the number of sensor inputs (3-channel or 4-channel technology).

The PPC-06-plus and PPC-08-plus can measure, store and process all relevant hydraulic parameters such as pressure, differential pressure, temperature, rotational speed and flow. The comprehensive programmer options, and the internal memory capacity in particular, allow for diverse measurement and evaluation methods such as long-term measurements, trigger functions or measuring data from third-party sensors.

The PPC-06/08-plus devices can store up to 1000000 measuring value points and 240000 curve memory points. The stored values can be transferred using the built-in USB interface to a PC or to a notebook. The included PPC software is compatible with popular PC operating systems (Windows 95®, Windows 98®, Windows 2000®, Windows NT®, Windows XP®, Windows Vista® and Windows 7®) and permits various evaluation methods.

The automatic sensor recognition feature makes the PPC-06-plus and PPC-08-plus hydraulic testers easy to operate, and the testers can be individually configured to meet customer requirements without a great programming effort. Both hydraulic testers allow the data from third-party sensors to be measured and processed.

The units are also available as a complete set. Please see page D26.

\* FS = Full Scale

**Pressure Sensor ■ Type PPC-04/12-PT/2**



PPC-04/12-PT/2 with adaptor and cable

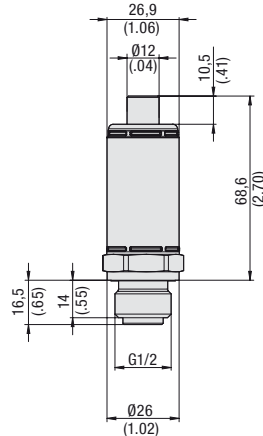

SDA20-G1/2-C6F

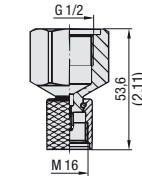

SAD20/15-P-C6F

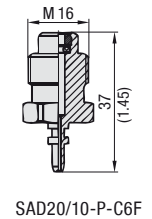
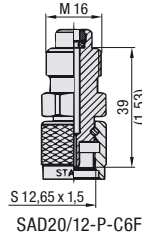
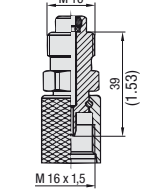

**Product Description**

The PPC-04/12-PT/2 Pressure Sensors can be used with all hydraulic testers of the PPC series, due to their 5-Pin connection.

As an additional feature, the new generation of PPC-04/12-PT Sensors (identified with „/2“ in the name) can now also measure and display temperature (only with the PPC-06/08-plus and PPC-Pad hydraulic testers).

The STAUFF Pressure Sensors are a reliable and flexible solution for the PPC series because of their sturdy Stainless Steel design, the quick response times (< 1 ms) and the high accuracy ( $\pm 0,25\%$  FS\* typ.) with automatic sensor detection.

Note: A PPC-04/12-CAB3 (3 m / 9.84 ft) cable is needed to connect the PPC-04/12-PT/2 Pressure Sensors to the current PPC Hydraulic Testers. A PPC-04/12-CAB5-EXT (5 m / 16.40 ft) extension cable is also available as an accessory!

Note: The temperature measurement data from the PPC-04/12-PT/2 Sensors can only be displayed using the PPC-06/08-plus and PPC-Pad hydraulic testers.

The PPC-units allow the evaluation and further processing of the measured values obtained.

**Technical Data**

- Sturdy Stainless Steel housing (1.4301)
- FPM (Viton®) gasket
- Weight: 200 g / .44 lbs
- Suitable for gases and liquids (in the case of aggressive media, only after consultation)
- 5-Pin connection
- Pressure connection G1/2 (without adaptor)

**Ambient Conditions**

- Media temperature: max. +105 °C / +221 °F
- Ambient temperature: -25 °C ... +80 °C / -13 °F ... +176 °F
- Storage temperature: -20 °C ... +80 °C / -4 °F ... +176 °F
- Compensated range: -0 °C ... +85 °C / +32 °F ... +285 °F
- Load cycles (10<sup>6</sup>): 100

**Electrical Data and Output**

- Input voltage: 7 ... 12 V DC
- Current consumption: 5 mA
- Output signal: 0 ... 3 V DC
- Response time: 1 ms
- Long-term stability: < 0,2 % FS\* /a
- Vibration loading: IEC 68-2-6/10 ... 500 Hz
- Shock loading: IEC 68-2-29

**Connection Adaptors for PPC Pressure Sensors**

In addition to the PPC-04/12-PT/2 Pressure Sensors, different adaptors and adaptor sets are available that not only connect to the STAUFF Test 20 system (SDA20-G1/2-C6F) but also to the test points of the STAUFF Test 15/12/10 series (SAD20/15-P-C6F, SAD20/12-P-C6F, SAD20/10-P-C6F).

For further information please see the STAUFF Test section.

**Order Codes**



① Series and Type

Pressure Sensor **PPC-04/12-PT**

② Version

Please see table below

③ Calibration

Without calibration certificate **(none)**  
With calibration certificate **CAL**

**Pressure Range and Accuracies**

Version	Pressure Range and Accuracies							
Sensor PPC-04/12-PT-	Pressure Measuring Range (bar/PSI)	Type of Measurement	Maximum Pressure (bar/PSI)	Burst Pressure (bar/PSI)	Accuracy ( $\pm\%$ FS*) typ.	Accuracy ( $\pm\%$ FS*) max.	Temperature Measuring Range (°C/°F)	Accuracy Temp. Sensor( $\pm\%$ FS*)
015/2	-1 ... 15**	Relative pressure	30	150	0,25	0,5	-25 ... 105	1,5
	-14.5 ... 217		435	2175				
060/2	0 ... 60	Absolute pressure	120	500	0,25	0,5	-25 ... 105	1,5
	0 ... 870		1740	7251				
150/2	0 ... 150	Absolute pressure	300	900	0,25	0,5	-25 ... 105	1,5
	0 ... 2175		4351	13053				
400/2	0 ... 400	Absolute pressure	800	1200	0,25	0,5	-25 ... 105	1,5
	0 ... 5801		11603	17404				
600/2	0 ... 600	Absolute pressure	1200	1800	0,25	0,5	-25 ... 105	1,5
	0 ... 8702		17404	26106				
601/2	0 ... 600 ***	Absolute pressure	1200	2500	0,25	0,5	-25 ... 105	1,5
	0 ... 8702		17404	36259				

\* FS = Full Scale

\*\* 0 ... 15 bar (0 ... 217 PSI) when used with the PPC-04/2 series

\*\*\* Pressure peaks up to 1000 bar / 14503 PSI

Dimensional drawings: All dimensions in mm (in).

## Temperature Sensor ■ Type PPC-04/12-TS /TSH

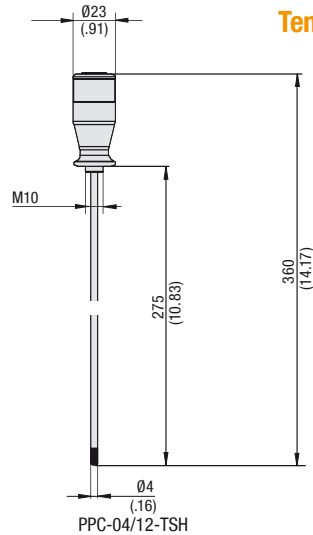
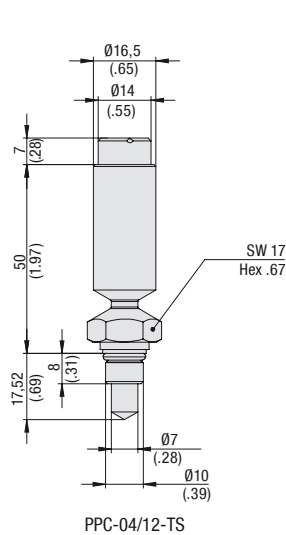

Temperature sensors TS and TSH with cables

## Order Codes

**PPC-04/12 - TS - CAL**

①

②

③

## ① Series and Type

 Temperatur Sensor **PPC-04/12**

## ② Version

 Screw-in **TS**  
 Rod-type **TSH**

## ③ Calibration

 Without calibration certificate **(none)**  
 With calibration certificate **CAL**

## Technical Data

**Materials**

- Housing (TS): Steel (C15K)
- Gaskets (TS): FPM (Viton®)
- Rod (TSH): Stainless Steel 1.4304
- Handle (TSH): Delrin
- Weight (TS): 100 g / .22 lbs
- Weight (TSH): 120 g / .26 lbs
- Measurement medium: liquids (consult STAUFF for use with aggressive media)

## ▪ 5-Pin connection

**Connection:**

- a) STAUFF Test connection SGV-16S-G-C6F in the pipeline (TS, see figure)
- b) Screw-in thread M10 x 1 (TS, see figure)
- c) Screw-in thread M10 (TSH)

**Ambient Conditions**

- Media temperature: max. +125 °C / +257 °F
- Ambient temperature: -25 °C ... +70 °C / -13 °F ... +158 °F
- Storage temperature: -25 °C ... +80 °C / -13 °F ... +176 °F

**Measuring Range**

- Measuring range: -25 °C ... +125 °C / -13 °F ... +257 °F
- Operating pressure (TS): 630 bar / 9137 PSI
- Maximum pressure (TS): 800 bar / 11603 PSI
- Burst pressure (TS): 1200 bar / 17404 PSI
- Accuracy: ±1,5 °C

**Electrical Data and Output**

- Output signal: 0 ...3 V DC
- Input signal: 7 ...12 V DC
- Response time  $T_{95}$  (TS): approx. 13,5 s
- Response time  $T_{95}$  (TSH): approx. 9,1 s
- IP 54 protection rating: Dust protected and protected against splashing water (TS)

## Product Description

The PPC-04/12-TS Screw-in Temperature Sensor measures current temperatures directly in the pipeline and is compatible with the PPC-04/12-SFM Flow Turbine (see page D21) and the SGV-16S-G-C6F straight threaded joint.

The new PPC-04/12-TSH Rod-type Temperature Sensor is especially designed to determine the media temperatures in tanks and containers.

Both sensors can measure media temperatures without problems up to +125 °C / +257 °F.

Note: A PPC-04/12-CAB3 (3 m / 9.84 ft) cable is needed to connect the PPC-04/12-TS or the PPC-04/12-TSH Temperature Sensors to the current PPC hydraulic testers. A PPC-04/12-CAB5-EXT (5 m / 16.40 ft) extension cable is also available as an option!

## Screw-in Hole PPC-04/12-TS

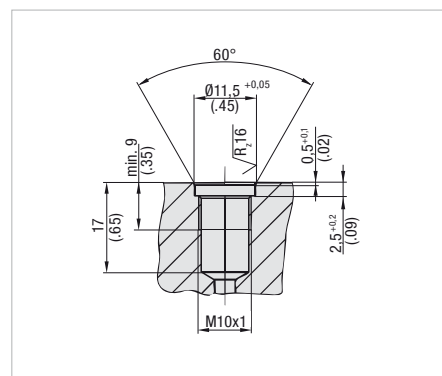

## SGV-16S-C6F with PPC-04/12-TS



For information on SGS-16-G-C6F please see the STAUFF Test section.

\* FS = Full Scale

Dimensional drawings: All dimensions in mm (in).

## Rotational Speed Sensor ■ Type PPC-04/12-SDS-CAB

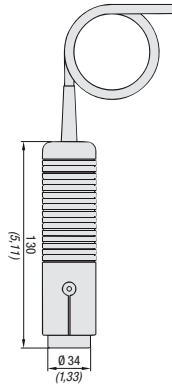

PPC-04/12-SDS-CAB

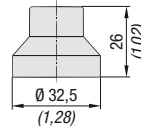

PPC-04/12-SFA-Focus Adaptor

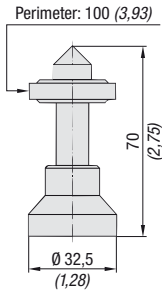

PPC-04/12-SKA-Contact Adaptor

### Product Description

The PPC-04/12-SDS-CAB Rotational Speed Sensor allows non-contact speed measurement of rotating components. The sensor is based on an opto-electrical measurement principle that determines the rotational speed with high accuracy using a reflecting strip on the shaft.

The contact rotational speed measurement is obtained by using a contact adaptor that is mounted to the sensor, and which makes contact with the rotating component during measurement.

This also produces high-accuracy measurement results. In the case of especially small areas, using the focusing adaptor facilitates measurement.

### Technical Data

- Material: ABS
- Weight: 230 g / .51 lbs
- 5-Pin connection
- Both contacting and non-contacting measurement possible
- Type of measurement: Optical, red LED

### Ambient Conditions

- Ambient temperature: 0°C ... +70°C / +32°F ... +158°F

### Measuring Range

- Measuring range: 20 ... 10000 RPM
- Measuring distance: 25 ... 500 mm (1 ... 20 in)
- Measuring angle: ±45 °C
- Accuracy: < ±0,5 % FS\*
- Resolution: ±5 RPM

### Electrical Data and Output

- Output signal: 0 ... 3 V DC
- Input signal: 7 ...12 V DC

Note: We recommend not extending the 2 m / 6.56 ft permanent cable connection provided on the sensor!

### Application Examples

**Fig. 1 -** Contacting rotational speed measurement with the contact adaptor.

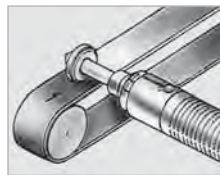

**Fig. 2 -** End face rotational speed measurement with the contact adaptor

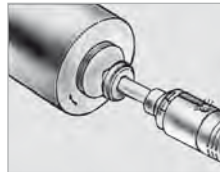

**Fig. 3 -** Rotating shaft / non-contacting rotational speed measurement using the focusing adaptor and marking strip

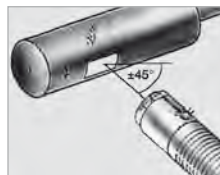

### Order Codes

PPC-04/12-SDS-CAB
- CAL

1
2

① **Series and Type**

Rotational Speed Sensor **PPC-04/12-SDS-CAB**

② **Calibration**

Without calibration certificate **(none)**  
 With calibration certificate **CAL**

### Order Codes

#### Focus Adaptor

PPC-04/12-SFA-focus adaptor

1

① **Series and Type**

Focus Adaptor **PPC-04/12-SFA-focus adaptor**

#### Contact Adaptor

PPC-04/12-SKA-contact adaptor

1

① **Series and Type**

Contact Adaptor **PPC-04/12-SKA-contact adaptor**

## Flow Turbine ■ Type PPC-04/12-SFM

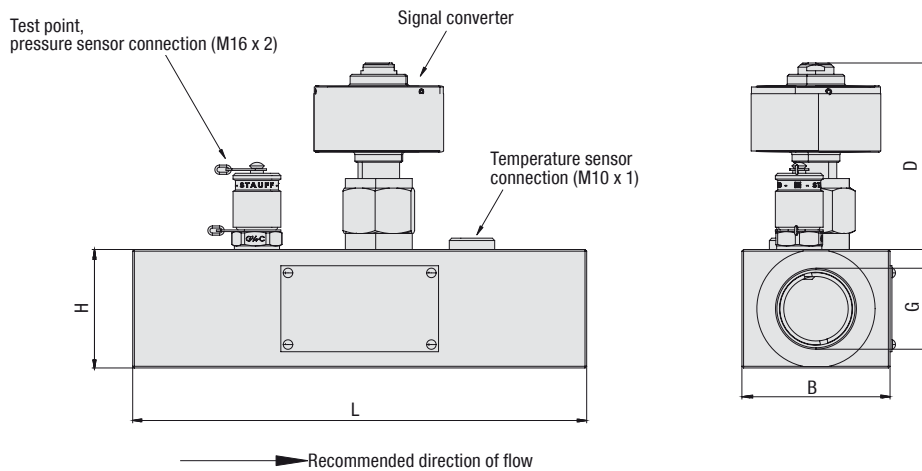

## Order Codes

**PPC-04/12 - SFM-015 - CAL**

①

②

③

## ① Series and Type

 Flow Turbine **PPC-04/12**

## ② Version

1 ... 15 l/min / .27 ... 3.90 US GPM	<b>SFM-015</b>
3 ... 60 l/min / .79 ... 15.90 US GPM	<b>SFM-060</b>
5 ... 150 l/min / 1.32 ... 39.60 US GPM	<b>SFM-150</b>
8 ... 300 l/min / 2.11 ... 79.00 US GPM	<b>SFM-300</b>
15 ... 600 l/min / 3.96 ... 158.00 US GPM	<b>SFM-600</b>

## ③ Calibration

Without calibration certificate	<b>(none)</b>
With calibration certificate	<b>CAL</b>

UNF version available on request.

## Technical Data

**Materials**

- Housing: Aluminium (black anodised)
- Gaskets: FPM (Viton®)

- 5-Pin connection
- Pressure measurement connection: SMK20 (M16 x 2)
- Temperature measurement connection: M10 x 1 (standard screw plug)

**Ambient Conditions**

- Media temperature: -20°C ... +90°C / -4°F ... +194°F
- Ambient temperature: -10°C ... +50°C / +14°F ... +122°F
- Storage temperature: -20°C ... +80°C / -4°F ... +176°F
- Permissible particle size: <10 Micron for SFM-015, <25 Micron for others

Note: To ensure the permissible particle size the use of a filter in front of the Flow Turbine is recommended.

- Viscosity range: 10 ... 100 cSt

**Electrical Data and Output**

- Response time: 50 ms

**Process Connection**

- Please see table below

## Product Description

The PPC-04/12-SFM Flow Turbine is permanently installed in the pipeline. The oil flow rotates the internal axial turbine. The frequencies generated are processed by digital electronics (a signal converter). Flow effects causing interference are compensated in this process.

The signal converter is now directly integrated into the PPC-04/12-SFM Flow Turbine. This allows even simpler operation and supports permanent coupling of the turbine and signal converter components that are matched to one another.

The new turbine also improves the response times (from previously 400 ms to 50 ms) and increases the measuring accuracy.

The PPC-04/12-SFM Flow Turbine is available in five versions for various flow speeds.

A pressure sensor (see page D18) can be connected in parallel to the flow turbine by way of the integrated test point. In addition, the oil temperature can also be measured using the temperature sensor connection (see page D19).

In general, the PPC-04/12-SFM Flow Meter can handle flows in either direction. The specified technical data and the calibration (available as an option) apply only when the flow through the flow meter matches the recommended flow direction.

A double-headed arrow is shown on the nameplate of the PPC-04/12-SFM. The thicker end of the double-headed arrow specifies the recommended direction of flow.

Note: A PPC-04/12-CAB3 (3 m / 9.84 ft) cable is needed to connect the PPC-04/12-SFM Flow Meter to the current PPC hydraulic testers.

A PPC-04/12-CAB5-EXT (5 m / 16.40 ft) extension cable is also available as an option!

## Dimensions and Measuring Range

Version	Measuring Range						Dimension (mm/in)						Weight (lb)
	Measuring Range (l/min / US GPM)	Max. Flow (l/min / US GPM)	Operating Pressure (bar / PSI)	Max. Pressure (bar / PSI)	Accuracy (at 21 cSt)	Max. Pressure Drop (at FS*) (bar / PSI)	G ** (BSP)	G (UNF)	B	D	L	H	
SFM-015	1 ... 15	16,5	350	420	±1 (% FS*)	1,5	G1/2	3/4-16	37	80	136	37	650
	.27 ... 3.90	4.4	5076	6091		21.8							
SFM-060	3 ... 60	66	350	420	±1 (% of the displayed value)	1,5	G3/4	1-1/16-16	62	80	190	50	750
	.79 ... 15.90	17.4	5076	6091		21.8							
SFM-150	5 ... 150	165	350	420	±1 (% of the displayed value)	1,5	G3/4	1-1/16-16	62	80	190	50	750
	1.32 ... 39.60	43.6	5076	6091		21.8							
SFM-300	8 ... 300	330	350	420	±1 (% of the displayed value)	4	G1	1-5/16-16	62	84	190	50	1200
	2.11 ... 79.00	87.2	5076	6091		58							
SFM-600	15 ... 600	660	290	348	±1 (% of the displayed value)	5	G1-1/4	1-5/8-12	62	75	212	75	1800
	3.96 ... 158.00	174.4	4206	5047		72.5							

\* FS = Full Scale

\*\* Standard option

Dimensional drawings: All dimensions in mm (in).

## Gear Flow Meter - Type PPC-04/12-SVC



### Product Description

The PPC-04/12-SVC Gear Flow Meter is permanently installed in the pipeline of the hydraulic system. Highly accurate, low-noise flow measurements can be performed with this meter because of a very accurate gear pair.

A wide range of viscosities can be handled and even values for aggressive media (brakefluids, Skydrole, biodegradable lubricants, isocyanates, greases, etc.) can be measured by using different gaskets.

The PPC-04/12-SVC Gear Flow Meter is available in four versions (up to 300 l/min, 79 US GPM) and is resistant to pressures up to 400 bar / 5801 PSI or 315 bar / 4568 PSI.

The PPC-04/12-SVC Gear Flow Meter always includes a connection plate and a signal converter (both already assembled).

The specified engineering values and the calibration available optionally apply only if the PPC-04/12-SVC Flow Meter is installed in the recommended direction of flow (from A to B). Appropriate markings are engraved on the flow meter.

### Technical Data

#### Materials

- Housing: GGG 40
- Gaskets: FPM (Viton®)

- 5-Pin connection
- Response time: 400 ms

#### Ambient Conditions and Measuring Range

- Max. media temp.: +110 °C / +230 °F
- Ambient temperature: +10 °C ... +50 °C / +50 °F ... +122 °F
- Storage temperature: -20 °C ... +80 °C / -4 °F ... +176 °F
- Permissible particle size: < 25 Micron
- Viscosity range: see the charts

#### Process Connections

- Please see table on page D23

Note: A PPC-04/12-CAB3 (3 m / 9.84 ft) cable is needed to connect the PPC-04/12-SVC flow meter to the current PPC hydraulic testers.

A PPC-04/12-CAB5-EXT (5 m / 16.40 ft) extension cable is also available as an option!

### Order Codes

PPC-04/12

- SVC-015

- CAL

①
②
③

#### ① Series and Type

Gear Flow Meter **PPC-04/12**

#### ② Version

0,2 ... 15 l/min / .05 ... 3.90 US GPM	<b>SVC-015</b>
0,4 ... 60 l/min / .10 ... 15.90 US GPM	<b>SVC-060</b>
0,6 ... 150 l/min / .20 ... 39.60 US GPM	<b>SVC-150</b>
1 ... 300 l/min / .30 ... 79 US GPM	<b>SVC-300</b>

#### ③ Calibration

Without calibration certificate	<b>(none)</b>
With calibration certificate	<b>CAL</b>

### Pressure Drop Curves / Viscosity Curves

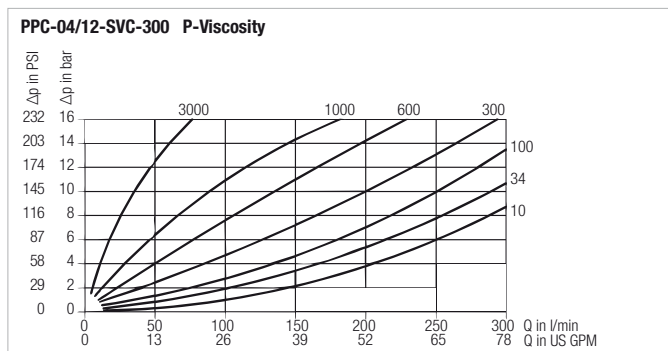
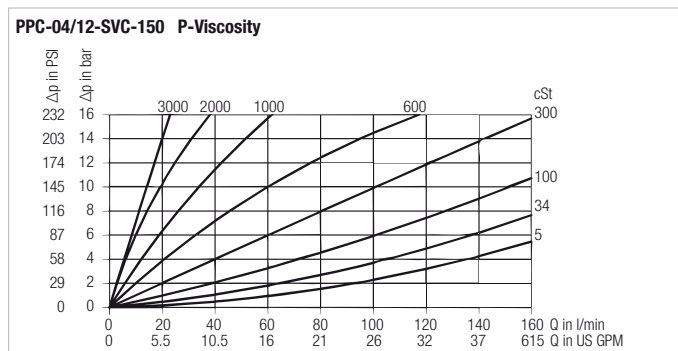
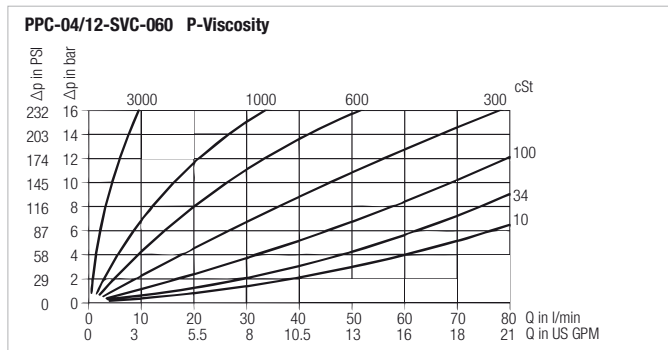
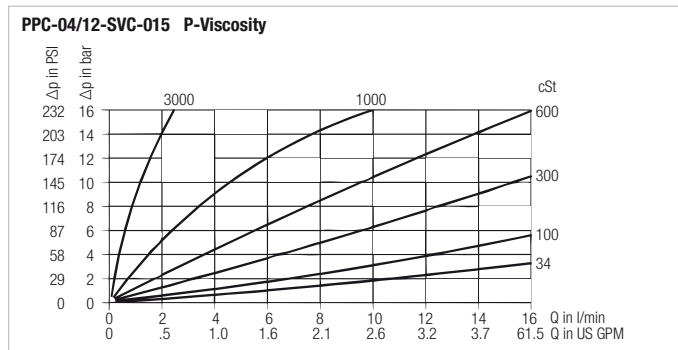

## Gear Flow Meter ■ Type PPC-04/12-SVC

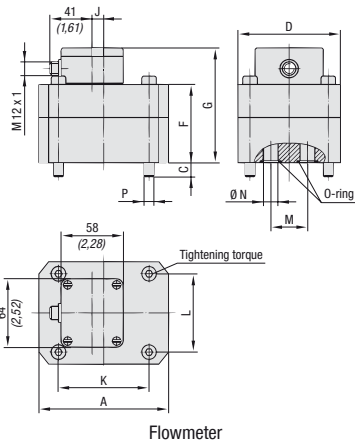

Flowmeter

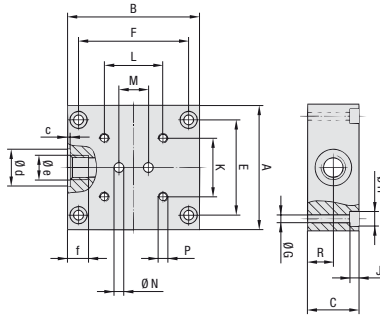

Connection Plate

## Measuring Ranges

Version	Measuring Ranges		Operating Pressure	Maximum Pressure	Accuracy	Maximum Pressure Drop	Total Weight
Flow Meter	Measuring Range	Maximum Flow	(bar/PSI)	(bar/PSI)	(at 21 cSt)	(at FS*) (bar/PSI)	(kg/lbs)
PPC-04/12-	(l/min / US GPM)	(l/min / US GPM)					
SVC-015	0,2 ... 15	16,5	400	480	±0,5 (% FS*)	see the chart	3,8
	.05 ... 3.90	4.40	5800	7300			8
SVC-060	0,4 ... 60	66	400	480	±0,5 (% FS*)	see the chart	8,1
	.10 ... 15.90	17.40	5800	7300			17.9
SVC-150	0,6 ... 150	165	315	375	±0,5 (% FS*)	see the chart	23
	.20 ... 39.60	43.60	4570	5440			50.7
SVC-300	1 ... 300	330	315	375	±0,5 (% FS*)	see the chart	27
	.30 ... 79	87.20	4570	5440			59.5

## Flow Meter Dimensions

Version	Dimensions (mm/in)												Torque [Nm]	Weight (kg/lbs)			
	A	C	D	F	G	J	K	L	M	N	P						
Flow Meter PPC-04/12-																	
SVC-015	85	13	60	57	94	-	70	40	20	9	M6	14	2				
	3.35	.51	2.36	2.24	3.70		2.76	1.57	.79	.35			4.4				
SVC-060	120	13	95	72	109	10,5	84	72	35	16	M8	35	5,2				
	4.72	.51	3.74	2.83	4.29	.41	3.31	2.83	1.38	.63			11.4				
SVC-150	170	18	120	89	140	46,5	46	95	50	25	M12	120	9				
	6.69	.71	4.72	3.50	5.51	1.83	1.81	3.74	1.97	.98			19.8				
SVC-300	170	22	120	105	142	40	46	95	50	25	M12	120	13				
	6.69	.87	4.72	4.13	5.59	1.57	1.81	3.74	1.97	.98			28.7				

## Connection Plate Dimensions

Version	Dimensions (mm/in)																	Weight (kg/lbs)	
	A	B	C	E	F	G	H	J	K	L	M	N	P	R	c	d	e		
Flow Meter PPC-04/12-																			
SVC-015	85	90	35	65	76	7	11	7	70	40	20	6,5	M6 x 14	17	0,7	25	G3/8 BSP	13	1,8
	3.35	3.54	1.38	2.56	2.99	.28	.43	.28	2.76	1.58	.79	.26	M6 x .55	.67	.03	.98		.51	2.7
SVC-060	100	120	37	80	106	7	11	7	84	72	35	12	M8 x 18	17,5	0,7	29	G1/2 BSP	15	2,9
	3.94	4.72	1.46	3.15	4.17	.28	.43	.28	3.31	2.83	1.38	.47	M8 x .71	.69	.03	1.14		.59	5.4
SVC-150	160	165	80	140	145	9	15	9	46	95	50	25	M12 x 28	28,5	1	42	G1 BSP	19	14
	6.30	6.50	3.15	5.51	5.71	.35	.59	.35	1.81	3.74	1.97	.98	M12 x 1.10	1.12	.04	1.65		.75	37.5
SVC-300	160	165	80	140	145	9	15	9	46	95	50	25	M12 x 28	28,5	1	42	G1 BSP	19	14
	6.30	6.50	3.15	5.51	5.71	.35	.59	.35	1.81	3.74	1.97	.98	M12 x 1.10	1.12	.04	1.65		.75	37.5

\*FS = Full Scale

Dimensional drawings: All dimensions in mm (in).

Miscellaneous Measurements (only for PPC-06/08-plus and PPC Pad)

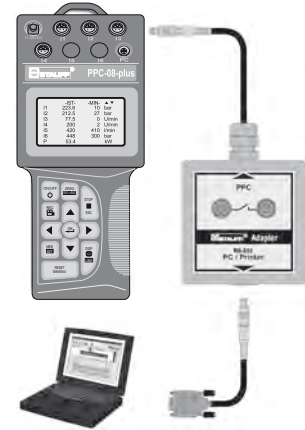

Characteristics

In addition to pressure, temperature, rotational speed and flow measurements, the PPC-06/08-plus Hydraulic Testers can measure and evaluate different signals from other or third-party sensors. The following connecting adaptors are available for these tasks:

- Current /Voltage Adaptor: PPC-06/12-A/V-A adaptor
- External Trigger Adaptor: PPC-06/12-TR-A adaptor

**ATTENTION! None of the two adaptors is suitable for use with the PPC-04/2.**

Current / Voltage Adaptor

Measuring electrical signals or signals from a third-party sensor (e.g. 4 ... 20 mA, 0 ... 10 V, ...) with the PPC-06/12-A/V-A adaptor.

The PPC-06/12-A/V-A Current / Voltage Adaptor is used, for example, for measuring current at proportional valves or for determining the switching states of motors or pumps and to evaluate and process measurements from third-party sensors. Typical applications are the generation and measurement of a force-distance graph or torque-flow characteristic curves. The following input signals can be processed by this adaptor:

- Electric currents up to 4 A DC
- Electric voltages up to 48 V DC

The measured data are transmitted directly to the PPC-06/08-plus or PPC Pad hydraulic tester by a permanent cable connection.

Order Code

**PPC-06/12-A/V-A adaptor**

①

① **Series and Type**  
Current / Voltage Adaptor **PPC-06/12-A/V-A adaptor**

External Trigger Adaptor

External triggering of memory measurements using the PPC-06/12-TR-A adaptor.

External signals such as relay contacts may be used as start signals for recording measured values in the PPC-06/08-plus or PPC-Pad hydraulic testers (recording starts when a pump starts or a valve opens). The PPC-06/12-TR-A Adaptor is connected directly to a PC, so that external relay triggering operates during online measurements.

Order Code

**PPC-06/12-TR-A adaptor**

①

① **Series and Type**  
External Trigger Adaptor **PPC-06/12-TR-A adaptor**



## Cables / Adaptors / Accessories



PPC-04/12-CAB3 and PPC-04/12-CAB5-EXT



PPC-04/12-U5P-S4P adaptor



PPC-04/12-CAB2-U4P-S5P cable



PC connecting cable as a component of the PC-SET-04-SW-CAB



PC connecting cable as a component of the PC-SET-06/08-plus-SW-CAB



PPC-04/12-R232-to-USB-CAB PC adaptor cable

## Characteristics

A number of cables, adaptors and accessories are also available. With these items, you may customize your hydraulic tester to your needs or ensure continued use of old sensors or measuring equipment. The following items are available for this purpose:

**PPC-04/12-CAB3 Cable and PPC-04/12-CAB5-EXT Cable**

A PPC-04/12-CAB3 cable is required to connect the sensors to the current hydraulic testers of the PPC-04/2, PPC-06/08-plus series or PPC Pad. The cable comes with a 5-pin push/pull connection at each end and has a length of 3 m / 9.84 ft.

Note: This cable cannot be used with older hydraulic testers and/or sensors (with the 4-pin connection)!

The PPC-04/12-CAB5-EXT cable has a length of 5 m / 16 ft.

Note: Please keep in mind that it is generally recommended not to exceed a total cable length of 8 m / 26.25 ft!

**PPC-04/12-U5P-S4P Adaptor**

It is no longer possible to use the old 4-pin measuring sensors when converting the PPC-04 series (sensors and hydraulic testers) to the current version using 5-pin connections without suitable adaptors. The simple and easy solution to this is the PPC-04/12-U5P-S4P adaptor.

The adaptor has a 5-pin connection (connecting to the current PPC-04/2, PPC-06/08-plus hydraulic tester or PPC Pad) at one end and a 4-Pin push/pull connector (for connecting an older sensor) at the other end.

**PPC-04/12-CAB2-U4P-S5P Cable**

The PPC-04/12-CAB2-U4P-S5P cable is intended for using current sensors (5-pin connection) with older hydraulic testers of the PPC-04 series (without the "2" in the name, with the 4-pin sensor input). This adaptor cable has a length of 2 m / 6.56 ft, a 4-Pin connection (for connecting to the old PPC-04 hydraulic tester) on one end and a 5-pin push/pull connector (for connecting to the current measuring sensor) on the other end.

## Order Codes

**PPC-04/12-CAB3**

①

## ① Series and Type

Standard Connecting Cable for Measuring Sensor	<b>PPC-04/12-CAB3</b>
Extension Cable	<b>PPC-04/12-CAB5-EXT</b>

## Order Code

**PPC-04/12-U5P-S4P adaptor**

①

## ① Series and Type

Adapting older Sensors to current Hydraulic Testers	<b>PPC-04/12-U5P-S4P adaptor</b>
---	----------------------------------

## Order Code

**PPC-04/12-CAB2-U4P-S5P**

①

## ① Series and Type

Adapting current Sensors to older Measuring Equipment	<b>PPC-04/12-CAB2-U4P-S5P</b>
---	-------------------------------

**PC-SET PPC-04-SW-CAB**

It is possible to connect the PPC-04-AP/2 hydraulic tester to a PC or notebook. The set contains one PC cable with RS-232 connection (2 m / 6.56 ft) and the corresponding PC software. The PC-SET PPC-04-SW-CAB is only suitable for the PPC-04-AP/2 (to be ordered optionally) because the other two testers of the PPC-04/2 series do not have a data output.

## Order Code

**PC-SET PPC-04-SW-CAB**

①

## ① Series and Type

PC Set	<b>PC-SET PPC-04-SW-CAB</b>
--------	-----------------------------

**PC-SET PPC-06/08-PLUS-SW-CAB**

A PC set, consisting of a USB connecting lead, length 1,5 m / 4.92 ft and the corresponding PC software. Note: The appropriate PC set is automatically included when purchasing a PPC-06/08-plus or PPC-Pad hydraulic tester.

## Order Code

**PC-SET PPC-06/08-plus-SW-CAB**

①

## ① Series and Type

PC Set	<b>PPC-SET PPC-06/08-PLUS-SW-CAB</b>
--------	--------------------------------------

**PPC-04/12-R232-to-USB-CAB Adaptor**

A suitable PC cable (PPC-Set PPC-04-SW-CAB) is available for connecting a hydraulic tester of the PPC series to a PC. As standard, this cable is equipped with a connection for the RS-232 interface. For connection to a USB port, the PPC-04/12-RS232-to-USB-CAB adaptor is also available. The cable has a length of 1 m / 3.3 ft.

## Order Code

**PPC-04/12-RS232-to-USB-CAB**

①

## ① Series and Type

Adaptor Cable	<b>PPC-04/12-RS232-to-USB-CAB</b>
---------------	-----------------------------------

## Hydraulic Tester ■ Type PPC Complete System



Complete System PPC-04/2



Complete System PPC-06/08-plus

### Product Description

PPC complete systems are assembled in different versions according to customer wishes. The complete systems are supplied in a handy case with individually designed pockets/sections and have space for the components listed beside.

### Components

#### Standard option PPC-04/2 complete system

- 1x PPC-04/2 hydraulic tester
- 1x Power supply unit
- Up to 3 pressure sensors with installed adaptor for STAUFF Test 20 (M16 x 2)
- Up to 2 connecting cables (3 m / 9.84 ft)
- 1x TS temperature sensor, with installed SGV-16S-G-C6F (optional)
- 3x SAD adaptors for the STAUFF Test 15/12/10 series (standard for all PPC complete systems)
- 1x Operating instructions (multilingual) on CD

#### Standard option PPC-06/08-plus complete system

- 1x PPC-06-plus or PPC-08-plus hydraulic tester
- 1x Power supply unit
- Up to 3 pressure sensors with installed adaptor for STAUFF Test 20 (M16 x 2)
- Up to 3 connecting cables (3 m / 9.84 ft)
- 1x TS temperature sensor, with installed SGV-16S-G-C6F (optional)
- 3x SAD adaptors for the STAUFF Test 15/12/10 series (standard for all PPC complete systems)
- 1x Printed user manual (German and English)
- 1x User manual (multilingual) on CD
- 1x PC software for the PPC-06/08-plus
- 1x PC connecting cable

Note: Please consult STAUFF for calibrated version.

### Order Codes

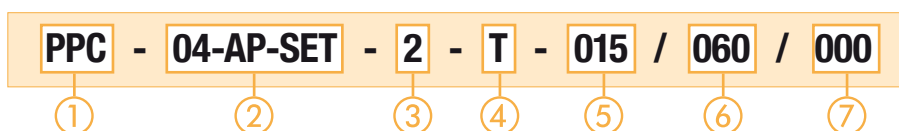

#### ① Series and Type

STAUFF Hydraulic Tester **PPC**

#### ② Version

2 Sensor inputs, without internal data memory, battery-operated	<b>04-B-SET</b>
2 Sensor inputs, without internal data memory, with rechargeable battery, power supply unit, without data output	<b>04-A-SET</b>
2 Sensor inputs, without internal data memory, with rechargeable battery, power supply unit and data output	<b>04-AP-SET</b>
3 Sensor inputs, including PC software and PC connecting cable	<b>06-SET</b>
4 Sensor inputs, including PC software and PC connecting cable	<b>08-SET</b>

#### ③ Number of Pressure Sensors

With one pressure sensor	<b>1</b>
With two pressure sensors	<b>2</b>
With three pressure sensors	<b>3</b>

#### ④ Temperature Sensor

Without TS temperature sensor with SGV	<b>(none)</b>
With TS temperature sensor with SGV	<b>T</b>

#### ⑤ Pressure Range and Pressure Sensor

First pressure sensor	<b>see table</b>
-----------------------	------------------

#### ⑥ Pressure Range and Pressure Sensor

Second pressure sensor	<b>see table</b>
------------------------	------------------

#### ⑦ Pressure Range and Pressure Sensor

Third pressure sensor	<b>see table</b>
-----------------------	------------------

### Pressure Ranges and Pressure Sensor

Pressure Range	Pressure Sensor		
<b>000</b>	When ordering a complete system with one or two pressure sensors, specify „000“ for the pressure range of the second and / or third sensors.		
<b>015</b>	Pressure range first pressure sensor	Pressure range second pressure sensor	Pressure range third pressure sensor
<b>060</b>			
<b>150</b>			
<b>400</b>			
<b>600</b>			
<b>601</b>			
<b>e.g.</b>	<b>015 (15 bar PT)</b>	<b>060 (60 bar PT)</b>	<b>000 (0 bar PT)</b>

Please keep in mind that two pressure sensors with identical measuring ranges are necessary for differential pressure measurements.

## Hydraulic Test Equipment

Group	Description	Order Codes	Page
<b>1. Hydraulic Tester PPC-04/2</b>	Hydraulic Tester PPC-04-B/2 with 2 sensor inputs, without data memory, with battery	PPC-04-B/2	D16
	Hydraulic Tester PPC-04-A/2 with 2 sensor inputs, without data memory, including rechargeable battery and power supply unit (110/230 V AC)	PPC-04-A/2	D16
	Hydraulic Tester PPC-04-AP/2 with 2 sensor inputs, without data memory, including rechargeable battery and power supply unit (110/230 V AC) and data output (without PC set)	PPC-04-AP/2	D16
<b>2. Hydraulic Tester PPC-06/08-plus</b>	Hydraulic Tester PPC-06-plus with 3 sensor inputs, including PC software and PC connecting cable, including power supply unit	PPC-06-plus	D17
	Hydraulic Tester PPC-08-plus with 4 sensor inputs, including PC software and PC connecting cable, including power supply unit	PPC-08-plus	D17
<b>3. Pressure Measurement</b> (for connecting and extension cables for measuring transmitters, see item 8)	<b>Pressure Sensor G 1/2</b> (without connecting cable)		
	Pressure range from -1 ... 15 bar / -14.5 ... 217 PSI relative pressure *	PPC-04/12-PT-015/2	D18
	Pressure range from 0 ... 60 bar / 0 ... 870 PSI absolute pressure	PPC-04/12-PT-060/2	D18
	Pressure range from 0 ... 150 bar / 0 ... 2175 PSI absolute pressure	PPC-04/12-PT-150/2	D18
	Pressure range from 0 ... 400 bar / 0 ... 5801 PSI absolute pressure	PPC-04/12-PT-400/2	D18
	Pressure range from 0 ... 600 bar / 0 ... 8702 PSI absolute pressure	PPC-04/12-PT-600/2	D18
	Pressure range from 0 ... 600 bar / 0 ... 8702 PSI absolute pressure **	PPC-04/12-PT-601/2	D18
	<b>Connection Adaptors</b>		
Adaptor G 1/2 to M16 x 2 (STAUFF Test 20)	SDA20-G1/2-C6F	D18	
Adaptor M 16 x 2 to M16 x 1,5 (STAUFF Test 20 to STAUFF Test 15)	SAD20/15-P-C6F	D18	
Adaptor M 16 x 2 to S12,65 x 1,5 (STAUFF Test 20 to STAUFF Test 12)	SAD20/12-P-C6F	D18	
Adaptor M 16 x 2 to plug-in (STAUFF Test 20 to STAUFF Test 10)	SAD20/10-P-C6F	D18	
<b>4. Temperature Measurement</b> (for connecting and extension cables for measuring transmitters, see item 8)	Temperature Sensor -25 °C ... +125 °C / -13 °F ... +257 °F for pipeline installation	PPC-04/12-TS	D19
	Rod-type Temperature Sensor -25 °C ... +125 °C / -13 °F ... +257 °F for tank /container measurements	PPC-04/12-TSH	D19
	Straight threaded Adaptor with M10 x 1 connection (for the PPC-04/12-TS)	SGV-16S-G-C6F	D19
<b>5. Rotational Speed Measurement</b>	Rotational Speed Sensor with integrated connecting cable 2 m / 6.56 ft	PPC-04/12-SDS-CAB	D20
	Contact Adaptor	PPC-04/12-SKA-contact adaptor	D20
	Focusing Adaptor	PPC-04/12-SFA-focus adaptor	D20
<b>6. Flow Measurement</b> (for connecting and extension cables for measuring transmitters, see item 8)	<b>SFM Flow Meters with Integrated Signal Converter</b>		
	Measuring range from 1 ... 15 l/min / .3 ... 3.9 US GPM	PPC-04/12-SFM-015	D21
	Measuring range from 4 ... 60 l/min / 1 ... 15.9 US GPM	PPC-04/12-SFM-060	D21
	Measuring range from 6 ... 150 l/min / 1.6 ... 39.6 US GPM	PPC-04/12-SFM-150	D21
	Measuring range from 10 ... 300 l/min / 2.7 ... 79 US GPM	PPC-04/12-SFM-300	D21
	Measuring range from 20 ... 600 l/min / 5.3 ... 158 US GPM	PPC-04/12-SFM-600	D21
	<b>SVC Flow Meters with Signal Converter and Connecting Plate</b>		
	Measuring range from 0,2 ... 15 l/min / .05 ... 3.9 US GPM	PPC-04/12-SVC-015	D22
Measuring range from 0,4 ... 60 l/min / .1 ... 15.9 US GPM	PPC-04/12-SVC-060	D22	
Measuring range from 0,6 ... 150 l/min / .2 ... 39.6 US GPM	PPC-04/12-SVC-150	D22	
Measuring range from 1 ... 300 l/min / .3 ... 79 US GPM	PPC-04/12-SVC-300	D22	
<b>7. Miscellaneous Measurements</b> (only PPC-06/08-plus and PPC-Pad)	External Trigger Adaptor	PPC-06/12-TR-A adaptor	D24
	Current/Voltage/ Third-party Sensor Adaptor (up to 4 A DC / 48 V DC)	PPC-06/12-A/V-A adaptor	D24
<b>8. Connecting Cables for measuring transmitters without integrated cable, extension cable or adapter</b>	Connecting cable 3 m / 9.84 ft (5-Pin connection on both ends)	PPC-04/12-CAB3	D25
	Extension cable 5 m / 16.40 ft (5-Pin connection on both ends)	PPC-04/12-CAB5-EXT	D25
	Adaptor cable from old (4-Pin) sensors to current (5-Pin) hydraulic testers	PPC-04/12-U5P-S4P adaptor	D25
	Adaptor cable from current (5-Pin) sensors to older (4-Pin) hydraulic testers	PPC-04/12-CAB2-U4P-S5P	D25
<b>9. PC Connection and Software</b>	PC software and PC adaptor for PPC-04/2 (RS-232 connection)	PC-SET PPC-04-SW-CAB	D25
	PC software and USB connection lead for PPC-06/08-plus	PC-SET PPC-06/08-plus-SW-CAB	D25
	Adaptor cable RS-232 to USB for PPC	PPC-04/12-RS232-to-USB-CAB	D25
<b>10. Accessories and Spare Parts</b>	Power supply unit (110 / 230 V AC) for PPC-04/2, PPC-06/08-plus	PPC-04/12-110V/230V	D26
	PPC-04 case (with custom insert)	PPC-04 case	D26
	PPC-06/08-plus case (with custom insert)	PPC-06/12 case	D26

All available individual components for the PPC-04/2, PPC-06-plus and PPC-08-plus hydraulic testers, with their ordering codes, are listed below. They can be configured by the customer using this form. In the list, the components are sorted according to application areas/tasks to provide a better overview. For custom kits, please contact STAUFF.

\* 0 ... 15 bar / 0 ... 210 PSI relative pressure at PPC-04/2  
\*\* Pressure peaks up to 1000 bar / 14500 PSI

**All hydraulic testers and sensors are available in calibrated version. Please add -CAL to the order code.**

## Hydraulic Tester ▀ Type PPC Pad



### Product Description

The application possibilities for hydraulics have recently increased throughout all areas of drive and control systems. This trend has been particularly noticeable in the sectors of machine, plant and automotive construction. At the same time, hydraulics and electronics have become increasingly intertwined.

STAUFF's new hand-held measuring instrument – the PPC Pad – helps you to deal with these new trends. It has never been so easy to follow the complex processes in these sectors with measurement, display and analysis. Potential uses include preventative maintenance, commissioning, troubleshooting and machine optimization. The expanded requirements of these modern applications (such as the increased number of measurement points, longer cable lengths and high noise immunity) have driven further development of the CAN bus.

STAUFF's CAN bus sensors now take advantage of the bus system's automatic sensor detection capability to provide an easy-to-install Plug & Play solution. Compatibility with existing diagnostic sensors is also provided.

Our proven storage strategy is focused on MIN and MAX value measurements. Combined with a wide variety of value presentation styles, these features make effective solutions-oriented analysis possible.

The PPC-Soft-plus PC software offers additional methods for analysis, control and remote maintenance using LAN and USB connections. Together with this software, the PPC Pad is a truly user-friendly measuring instrument that can be used for any type of diagnostics application.

### Features

- Portable multi-function hand-held measuring instrument
- Pressure, temperature, flow and speed can be measured, monitored and analysed
- Measurement and display of over 50 channels
- Measured value display: numerical, bar graph, pointer, curve graph
- Project templates can be saved and loaded
- Interfaces: CAN, LAN, USB
- Total memory with up to 1 billion measured values
- Measured data can be (automatically) recorded, saved and analysed with the PPC-Soft-plus PC software and a LAN or USB connection

### Scope of Delivery

- PPC Pad
- Installed Handle
- 24 V DC / 2,5 A power pack incl. country adaptor
- M8 x 1 / 4-Pin (digital in/out)
- USB 2.0 cable (2 m / 6.56 ft)
- LAN cable (5 m / 16.40 ft)
- Operating instructions
- PC Software
- 1 GB microSD-memory card
- M12 cable socket for 4 ... 20 mA / 0 ... 10 V aux.sensors

### Technical Data

Please see page D32 for technical information.

### Order Codes

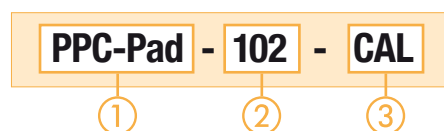

#### ① Series and Type

Hydraulic Tester	PPC-Pad
------------------	---------

#### ② Version

PPC-Pad-101	101
PPC-Pad-102	102
PPC-Pad-103	103

#### ③ Calibration (only -102 / -103)

Without calibration certificate	(none)
With calibration certificate	CAL

### Version Hydraulic Tester

Version	CAN-Sensor Inputs	Sensor Inputs with Sensor Recognition STAUFF (Analog)	Aux. Sensor Input (Analog)
PPC-Pad-101	2 networks	-	-
PPC-Pad-102	each with 8 sensors max.	3	2
PPC-Pad-103		6	4

## Hydraulic Tester ▀ Type PPC-Pad-SET



Content of case may differ

### Order Codes



#### ① Series and Type

Hydraulic Tester	<b>PPC-Pad</b>
------------------	----------------

#### ② Version

PPC-Pad-SET-101	<b>SET-101</b>
PPC-Pad-SET-102	<b>SET-102</b>
PPC-Pad-SET-103	<b>SET-103</b>

#### ③ Calibration (only -102 / -103)

Without calibration certificate	<b>(none)</b>
With calibration certificate	<b>CAL</b>

### Scope of Delivery

- PPC Pad
- Installed Handle
- 24 V DC / 2,5 A power pack incl. country adaptor
- M8 x 1 / 4-Pin cable socket (digital in/out)
- USB 2.0 cable (2 m / 6.56 ft)
- LAN cable (5 m / 16.40 ft)
- Operating instructions
- PC Software
- 1 GB microSD-memory card
- Equipment case
- Neck strap
- CAN connection cable (5 m / 16.40 ft)
- 2x Terminating resistor
- Analog connection cable (3 m / 9.84 ft)
- M12 cable socket aux. output

### Product Description

The PPC Pad is also available in a special designed case to store your unit and your accessories. The case is robust, lightweight and can be carried directly to your machine. It has individually designed inserts that can hold up to 4 pressure sensors, 1 CAN – flow turbine, 1 flow turbine, 1 frequency- and 1 aux-adaptor. Cable and additional equipment also have their own place inside.

PPC Pad case is the best way to store and protect your equipment.

Standard PPC-Pad-SET kits have been put together to equip a user with the basic equipment needed for basic measurement.

### Version Hydraulic Tester Set

Version	Hydraulic Tester	CAN-Sensor Inputs	Sensor Inputs with Sensor Recognition STAUFF (Analog)	Aux. Sensor Input (Analog)	Equipment Case	Neck Strap	CAN Connection Cable 5m / 16.40 ft	Terminating Resistor	Analog Connection Cable 3m / 9.84ft	Aux. Sensor analog - Cable Adaptor
PPC-Pad-SET-101	PPC-Pad-101	2 networks each with 8 sensors max.	-	-	1	1	2	2	-	-
PPC-Pad-SET-102	PPC-Pad-102		3	2	1	1	2	2	2	1
PPC-Pad-SET-103	PPC-Pad-103		6	4	1	1	2	2	3	2

Hydraulic Tester - Type PPC Pad

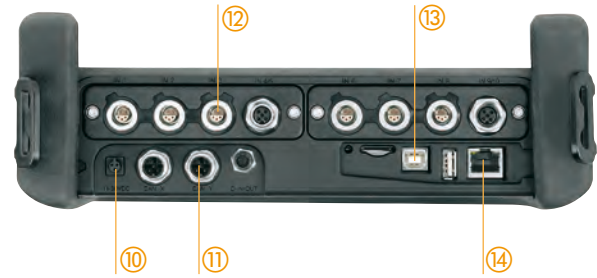

Function Specifications

- ① High protection from moisture and dirt due to cover caps and a rubber protective sleeve, Protection Class IP64
- ② Illuminated display for good readability in any situation
- ③ Protection of the housing, affording usage in tough environments and absorption of shocks
- ④ Big 5.7 in colour display for clearly viewing the extensive information
- ⑤ Intuitive operation due to clear-cut control elements and function-oriented keys
- ⑥ Ergonomic housing shape ensures convenient portability and long operating times
- ⑦ Large keyboard and fonts for easy operation and readability
- ⑧ Portable multi-function hand-held measuring instrument - strong in design and tough in operation
- ⑨ Easy to carry and hang up with carrying strip
- ⑩ 110 / 240 V AC power supply, battery life 8 hours, recharging time 3 hours
- ⑪ 2 x CAN-busnetworks with each 16 channels
- ⑫ Modular design for up to 6 analog sensors or 2 Highspeed channels (0,1 ms) automatic sensor recognition
- ⑬ PC Interface (USB 2.0); ACT/MIN/MAX measured value transmission to the PPC-Soft-plus software, terminal for USB mass storage devices
- ⑭ LAN interface for remote monitoring, micro SD memory card for storage enlargement

Connection of Analog Sensors / CAN Sensors

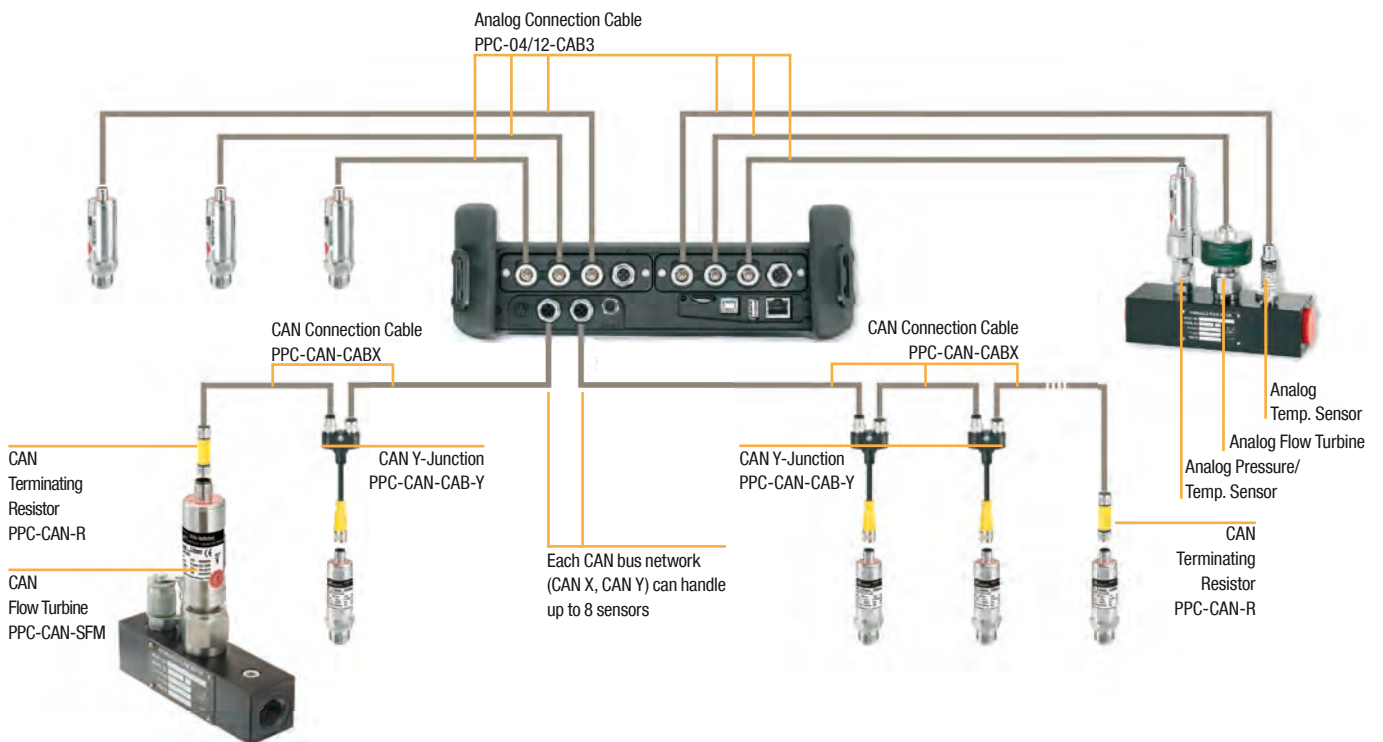

## Hydraulic Tester ■ PPC Pad Display

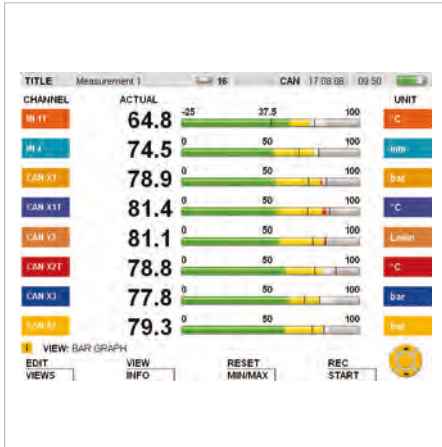

- Display of measured values as figures and bars
- Fixing of alarm ranges in green, yellow and red
- Trailing pointer function with MIN and MAX values

- Up to 4 channels in one large-format display
- Simultaneous display of ACT, MIN and MAX values
- Information lines of current settings, events and views
- Individual measurement channel identifier

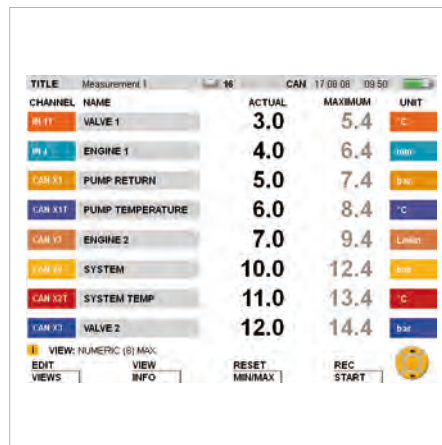
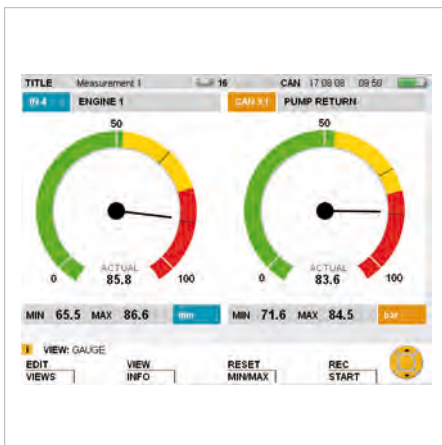

- Large-area pointer display of measured values
- Trailing pointer for MIN and MAX values
- Alarm range in green, yellow and red
- Further channels can be called up with the arrow keys

- Up to 8 channels in one display
- Colour allocation of the individual channels
- Uniform headings with measurement titles, sensors connected, interfaces, date, time and battery condition indicator
- Display can be changed between MIN and MAX values and full scale

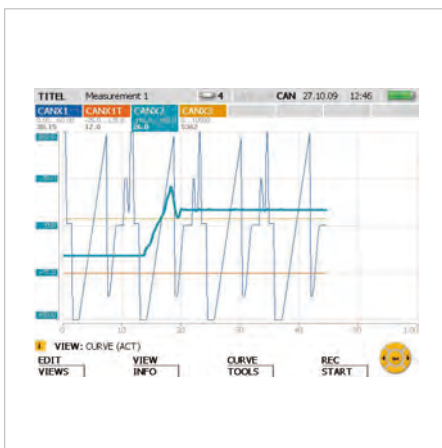

- Up to 8 channels in one graph display
- Fine, precise graph image thanks to high definition display
- Choice between ACT and MIN/MAX value display
- Automatic and manual scaling of the time axis for optimum measured value display

## Hydraulic Tester ▀ Type PPC Pad



### Technical Data (General)

#### Materials

- Housing material: ABS/PC (Thermoplastic)
- Housing protective sleeve material: TPE (Thermoplastic Elastomer)
- Housing/Protective Sleeve (incl. in Standard Shipment)

#### Dimensions and Weight

- Dimensions (w x h x d): 257 x 74.5 x 181 mm / 10.12 x 2.93 x 7.13 in
- Weight: 1550 g / 3.4 lbs (basic model)

#### Inputs / Outputs

- CAN sensor inputs: 2 CAN bus networks each with 8 sensors and max. 16 channels (for STAUFF CAN-Bus sensors) Scanning rate 1 ms = 1000 measured values/sec. M12x1 push-in connector, 5-Pin with SPEEDCON
- 1 digital trigger input: Scanning rate: 1 ms Input impedance: 1 k $\Omega$  Active high: >+7 ... +24 V DC Active low: <1 V DC Isolated
- 1 digital trigger output: Scanning rate: 1 ms max. switching signal: +24 V DC/max. 20 mA Isolated
- Push-in connector for digital input and output: M8 x 1 / 4-Pin, male

#### Module Slots

- 2, for input module, flexible placement possible
- Slot 1 = IN1, IN2, IN3, IN4/5
- Slot 2 = IN6, IN7, IN8, IN9/10 (Expandable only by STAUFF)

#### Display

- FT-LCD colour graphic display
- Visible area: 115 x 86 mm / 4.53 x 3.39 in
- Resolution: 640 x 480 pixels

#### Interfaces

- USB device: Online data transmission between unit and PC via PPC-Soft-plus Measured value transmission: ACT/MIN/MAX USB standard: 2.0, fullspeed Push-in connector: USB socket, shielded, type B

- USB host: Connection for mass storage devices such as USB stick or removeable hard disc Standard: 2.0, fullspeed, 100 mA max. Push-in connection: USB socket, shielded, type A
- Ethernet: Online data transmission between unit and PC via PPC-Soft-plus and remote control Measured value transmission: ACT/MIN/MAX Standard: 10, 100 Mbit/s, IEEE 802.3 (10/100 base T) Push-in connection: RJ45, socket, shielded

#### Functions

- Measurement: ACT, MIN and MAX values
- Measured value display: Numerical, bar graph, pointer, curve graph
- Measuring functions: Start/stop, points, trigger
- Trigger: Slope, manual, level, window, time, logic (interconnection of up to two events for the measurement start and stop)
- Pre-Trigger

- Remote operation via the Ethernet
- Acoustic notification at any incident

#### Measured Value Storage

- For storing measured values, project data and screen copies (screenshots)
- Storage capacity:  $\leq$ 4 million measured values per measurement Total measured value storage >1 billion measured values
- Storage format: ACT/MIN/MAX
- Storage interval: 1 ms to 24 h
- Storage duration: 1 ms to 300 h (trigger measurement)
- Internal: 64 MB (approx. 32 million measured values)
- External SD storage: up to 2 GB (1 GB Micro SD memory card included in standard shipment) Slot: Micro SD memory card
- External USB mass storage device: up to 40 GB

#### Ambient Conditions

- Operating temperature: 0 °C ... +50 °C / +32 °F ... +122 °F
- Storage temperature: -25 °C ... +60 °C / -13 °F ... +140 °F
- Relative humidity: < 80 %
- Environmental test: IEC60068-2-32 (1 m, free fall)

#### Power Supply

- Internal: Lithium ion pack, +7.4 V DC / 4500 mAh Battery charging circuit/operating time with 3 CAN sensors: > 8 h

#### Protection Rating

- IP64 protection rating: Dust tight and protected against splashing water

### Technical Data (for PPC-Pad-102 and 103)

#### Input with Sensor Recognition

- 3 or 6 sensor inputs (up to 6 or 12 analog measurement channels) with sensor recognition (p/T/Q/n) for PPC sensors
- Push-in connection: 5-Pin, push-pull, combination panel plug/socket
- Scanning rate: 1 ms = 1000 measured values/sec.
- For the PPC-04/12-PT combined pressure & temperature sensor, there is an additional temperature channel for each sensor input
- Temperature scanning rate: 1 s

#### Inputs for Auxiliary Sensors

- 2 analog sensor inputs: for measuring current and voltage Scanning rate: 1 ms = 1000 measured values/sec. Voltage measuring range: -10 ... +10 V DC (freely configurable) Current measuring range: 0/4 ... 20 mA Supply external sensors: +18 ... +24 V DC/max. 100 mA Push-in connection: M12x1, 5-Pin socket
- FAST mode: Scanning rate: 0.1 ms = 10000 measured values/sec. only one auxiliary sensor input is useable

#### Accuracy

- +0,02 % per °C

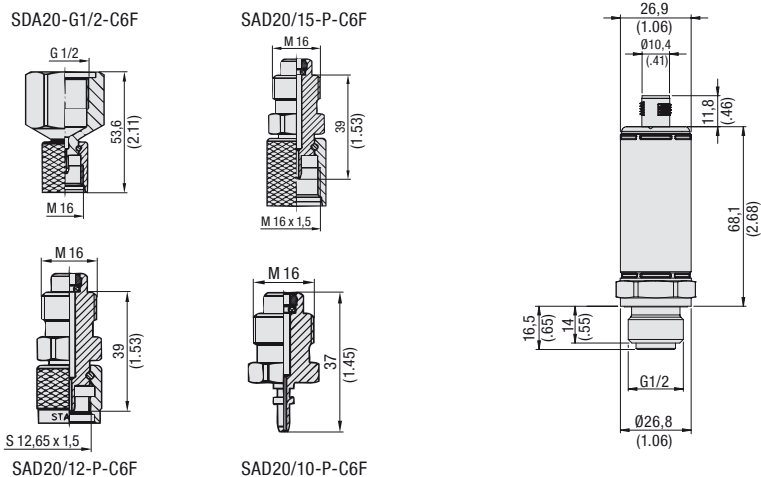

**CAN Pressure Sensor ■ Type PPC-CAN-PT**

**Connection Adaptors for PPC Pressure Sensors Technical Data**

In addition to the PPC-04/12-PT/2 Pressure Sensors, different adaptors and adaptor sets are available that not only connect to the STAUFF Test 20 system (SDA20-G1/2-C6F), but also to the test points of the STAUFF Test 15/12/10 series (SAD20/15-P-C6F, SAD20/12-P-C6F, SAD20/10-P-C6F).

For further information please see the STAUFF Test section.

- Sturdy Stainless Steel housing (1.4301)
- FPM (Viton®) gasket
- Sensor identification LED
- Weight: 200 g / .44 lbs
- Suitable for gases and liquids (in the case of aggressive media, only after consultation)
- 5-Pin SPEEDCON connection plug
- Pressure connection G1/2 (without adaptor)

**Ambient Conditions**

- Media temperature: max. 105 °C / 221 °F
- Ambient temperature: -25 °C ... 85 °C / -13 °F ... 185 °F
- Storage temperature: -25 °C ... 85 °C / -13 °F ... 185 °F
- Compensated range: 0 °C ... 85 °C / 32 °F ... 185 °F
- Load cycles (10<sup>6</sup>): 100

**CAN-open Interface**

- Protocol: DS 301 v4.1, Type 2.0 A
- Profil: DS 404 v1.2
- Special functions: LSS to DS 305 V2.0

**Electrical Data and Output**

- Input voltage: 8 ... 40 V DC
- Current consumption: 25 mA at 24 V DC
- Response time: 1 ms

**Product Description**

The PPC-CAN-PT Pressure Sensors are specially designed for the use with the new hydraulic tester PPC Pad. These sensors are using the CAN-open protocol to transfer the measurement values to the PPC Pad.

Most technical details are the same as with the new generation of the PPC-04/12-PT sensors. These CAN sensors can also measure and display temperature on the PPC Pad.

The STAUFF Pressure Sensors are a reliable and flexible solution for the PPC series because of their sturdy stainless steel design, the quick response times (< 1 ms) and the high accuracy ( $\pm 0,25\%$  FS\* typ.) with automatic sensor recognition.

A further new feature is the LED signal light on the top of the sensor, that shows the status of the sensor.

Connecting the PPC-CAN-PT Pressure Sensor to the hydraulic tester PPC Pad a cable and a terminating resistor is needed.

**Order Codes**
**PPC-CAN-PT - 016 - CAL**

①

②

③

**① Series and Type**

 CAN Pressure Sensor **PPC-CAN-PT**
**② Version**

Please see table below

**③ Calibration**

 Without calibration certificate **(none)**  
 With calibration certificate **CAL**
**Pressure Ranges and Accuracies**

Version	Pressure Ranges and Accuracies							
Sensor	Pressure Measuring Range (bar/PSI)	Type of Measurement	Maximum Pressure (bar/PSI)	Burst Pressure (bar/PSI)	Accuracy ( $\pm\%$ FS*) typ.	Accuracy ( $\pm\%$ FS*) max.	Temperature Measuring Range (°C/°F)	Accuracy Temp. Sensor ( $\pm\%$ FS*)
016	-1 ... 16	Relative pressure	32	150	0,25	0,5	-25 ... 105	1,5
	-14.5 ... 232		464	2175				
060	0 ... 60	Absolute pressure	120	500	0,25	0,5	-25 ... 105	1,5
	0 ... 870		1740	7251				
160	0 ... 160	Absolute pressure	320	900	0,25	0,5	-25 ... 105	1,5
	0 ... 2320		4641	13053				
400	0 ... 400	Absolute pressure	800	1200	0,25	0,5	-25 ... 105	1,5
	0 ... 5801		11603	17404				
600	0 ... 600	Absolute pressure	1200	1800	0,25	0,5	-25 ... 105	1,5
	0 ... 8702		17404	26106				
601	0 ... 600**	Absolute pressure	1200	2500	0,25	0,5	-25 ... 105	1,5
	0 ... 8702		17404	36259				

\* FS = Full Scale

\*\* Pressure peaks up to 1000 bar / 14503 PSI

SPEEDCON is a trademark of PHOENIX CONTACT GmbH &amp; Co. KG

## CAN Flow Turbine ▪ Type PPC-CAN-SFM

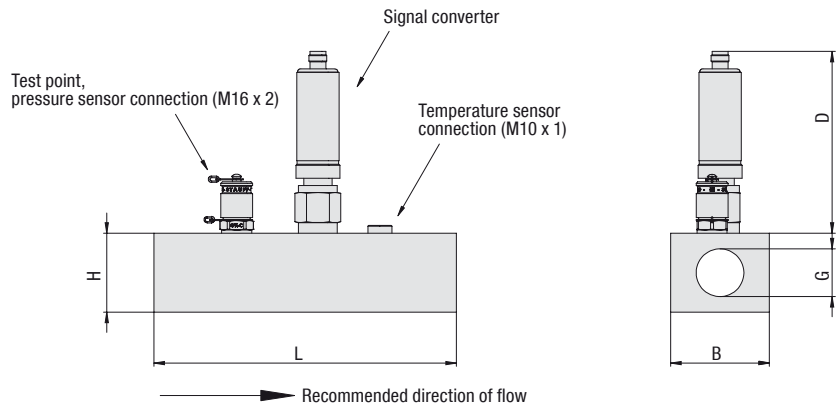

### Product Description

The PPC-CAN-SFM Flow Turbine is specially designed for the use with the new hydraulic tester PPC Pad and has to be installed permanently in the pipeline where the oil flow rotates the internal axial turbine. The generated frequencies are processed by digital electronics (a signal converter). Interferences caused by flow effects are compensated by this process. The signal converter is directly integrated into the PPC-CAN-SFM Flow Turbine. This allows even simpler operation and supports permanent coupling of the turbine and signal converter components that are matched to one another.

The new turbine also improves the response times/reaction times (from a previous 400 ms to 50 ms) and increases measurement accuracy.

The PPC-CAN-SFM Flow Turbine is available in five versions for various flow speeds. A pressure sensor (see page D33) can be connected in parallel to the flow turbine by the way of the integrated test point. In addition, the oil temperature can also be measured using the temperature sensor connection (see page D19).

In general, the PPC-CAN-SFM Flow Meter can handle flows in either direction. The specified technical data and the calibration (available as an option) apply only when the flow through the flow meter matches the recommended flow direction.

A double-headed arrow is shown on the nameplate of the PPC-CAN-SFM. The thicker end of the double-headed arrow specifies the recommended direction of flow.

Connecting the PPC-CAN-SFM Flow Meter to the hydraulic tester PPC Pad a cable and a terminating resistor is needed.

### Dimensions and Measuring Range

Version	Measuring Range						Dimension (mm/in)						Weight
Flow Turbine PPC-CAN-	Measuring Range (l/min / US GPM)	Max. Flow (l/min / US GPM)	Operating Pressure (bar / PSI)	Max. Pressure (bar / PSI)	Accuracy (at 21 cSt)	Max. Pressure Drop (at FS*) (bar / PSI)	G** (BSP)	G (UNF)	B	D	L	H	Weight (g/lbs)
SFM-015	1 ... 15	16,5	350	420	±1(% FS*)	1,5	G1/2	3/4-16	36,9	150	136	36,9	650
	.26 ... 3.90	4.4	5076	6091		21.8			1.45	5.90	5.35	1.45	1.43
SFM-060	3 ... 60	66	350	420	±1(% of the displayed value)	1,5	G3/4	1-1/16-16	62	164	190	49,6	750
	.79 ... 15.90	17.4	5076	6091		21.8			2.44	6.46	7.48	1.95	1.65
SFM-150	5 ... 150	165	350	420	±1(% of the displayed value)	1,5	G3/4	1-1/16-16	62	164	190	49,6	750
	1.32 ... 39.60	43.6	5076	6091		21.8			2.44	6.46	7.48	1.95	1.65
SFM-300	8 ... 300	330	350	420	±1(% of the displayed value)	4	G1	1-5/16-16	62	168	190	49,6	1200
	2.11 ... 79.00	87.2	5076	6091		58			2.44	6.61	7.48	1.95	2.65
SFM-600	15 ... 600	660	290	348	±1(% of the displayed value)	5	G1-1/4	1-5/8-12	62	183	212	75	1800
	3.96 ... 158.00	174.4	4206	5047		72.5			2.44	7.20	8.35	2.95	3.97

### Technical Data

#### Materials

- Housing: Aluminium (black anodised)
- Gaskets: FPM (Viton®)
- 5-Pin SPEEDCON connection plug
- Pressure measurement connection: SMK20 (M16 x 2)
- Temperature measurement connection: M10 x 1 (standard screw plug)

#### Ambient Conditions

- Media temperature: -20 °C ... +90 °C / -4 °F ... +176 °F
- Ambient temperature: +10 °C ... +60 °C / +50 °F ... +140 °F
- Storage temperature: -20 °C ... +80 °C / -4 °F ... +176 °F
- Permissible particle size: < 10 Micron for SFM-015 < 25 Micron for others
- Viscosity range: 10 ... 100 cSt

#### Electrical Data and Output

- Response time: 50 ms

### Order Codes



#### ① Series and Type

CAN Flow Turbine **PPC-04/12**

#### ② Version

1 ... 15 l/min / .27 ... 3.90 US GPM	<b>SFM-015</b>
3 ... 60 l/min / .79 ... 15.90 US GPM	<b>SFM-060</b>
5 ... 150 l/min / 1.32 ... 39.60 US GPM	<b>SFM-150</b>
8 ... 300 l/min / 2.11 ... 79.00 US GPM	<b>SFM-300</b>
15 ... 600 l/min / 3.96 ... 158.00 US GPM	<b>SFM-300</b>

#### ③ Calibration

Without calibration certificate	<b>(none)</b>
With calibration certificate	<b>CAL</b>

\* FS = Full Scale

\*\* Standard option

## Different CAN Connection Cables

Various cables are available to connect the CAN sensors and the CAN flow turbine to the PPC Pad. The CAN sensors work on a bus system as displayed in the connection overview on page D30. There are cables in length from 0,5 m / 1.64 ft and 20 m / 65.65 ft available. To connect a new sensor to the CAN bus, a Y-splitter cable is necessary.

Each sensor on the end of a CAN bus has to be closed with a terminating resistor. The resistor is also necessary when only one sensor is used. All connections are 5-Pin SPEEDCON connection plugs.

- Compact size
- Interference-free
- Compatible with all PPC-CAN sensors and diagnostic measuring instruments
- Push-Pull plug
- Various lengths available
- Oil-resistant material

### CAN Connection Cable - Type PPC-CAN-CAB



### Y-Splitter - Type PPC-CAN-CAB-Y



### CAN Terminating Resistor - Type PPC-CAN-R



#### Order Codes

**PPC-CAN - CAB2**

①

②

#### ① Series and Type

 CAN Connection Cable **PPC-CAN**

#### ② Length

0,5 m / 1.64 ft connection cable	<b>CAB0.5</b>
2 m / 6.65 ft connection cable	<b>CAB2</b>
5 m / 16.40 ft connection cable	<b>CAB5</b>
10 m / 32.81 ft connection cable	<b>CAB10</b>
20 m / 65.62 ft connection cable	<b>CAB20</b>

#### Order Code

**PPC-CAN-CAB-Y**

①

#### ① Series and Type

 Y-Splitter incl. 0,3 m / .98 ft **PPC-CAN-CAB-Y**

#### Order Code

**PPC-CAN-R**

①

#### ① Series and Type

 CAN Terminating Resistor **PPC-CAN-R**

## Product Description

### Measuring Frequency with PPC-CAN-FR

The PPC-CAN-FR can be used to connect frequency signals (for example, from turbines, flow counters or tachometers) to the PPC Pad.

The instruments can process sinus and rectangle signals from 1 Hz to 5 KHz with signal amplitude from 20 mV to 10 V. Configuration is possible via USB and PC software.

### Power Supply for the External Sensor

An external sensor can be supplied with 24 V using the PPC-CAN-FR.

### Analog or CAN Output

The PPC-CAN-FR can be connected either to an analog input or a CAN input.

## CAN Frequency Converter

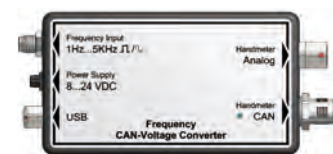

Frequency Converter PPC-CAN-FR

#### Order Code

**PPC-CAN-FR**

①

#### ① Series and Type

 Frequency Converter **PPC-CAN-FR**

#### Technical Data

##### Dimensions

- 114 x 64 x 26 mm / 4.49 x 2.52 x 1.02 in

##### Ambient Conditions

- Operating temperature: 0 °C ... +60 °C / +32 °F ... +140 °F
- Storage temperature: -25 °C ... +70 °C / -13 °F ... +158 °F
- Rel. humidity: < 80 %

##### Electrical Data and Output

- Measuring range: 1 Hz ... 5 KHz  
Sinus and rectangle signals  
40 mVpp ... 10 V pp
- Sensor power supply: 24 V DC ± 0,5 V DC
- I<sub>Out (Max.)</sub> without power supply: 50 mA
- I<sub>Out (Max.)</sub> with power supply at 24 V DC: 100 mA
- Accuracy: ±1 % FS\* ±0,05 % / °C

##### Power Supply

- Power supply (external): 8 ... 24 V DC

##### Electrical Connections

- Sensor: 4-Pin, M8, plug  
(Female with screw-in connections included with delivery)
- External power supply: 3-Pin, female
- USB: 4-Pin, female
- Analog: 5-Pin, female
- CAN: 5-Pin, M12

\* FS = Full Scale

## CAN Hydraulic Test Equipment

All available individual components for the PPC Pad hydraulic tester, with their ordering codes, are listed below. They can be configured by the customer using this form. In the list, the components are sorted according to application areas/tasks to provide a better overview. For custom kits, please contact STAUFF.

\*\* Pressure peaks up to 1000 bar / 14500 PSI

**All hydraulic testers (not PPC-Pad-101) and sensors are available in calibrated version. Please add -CAL to the order code.**

Group	Description	Order Codes	Page
<b>1. Hydraulic Tester PPC-Pad</b>	Hydraulic Tester PPC-Pad-101 with 2 CAN Networks, incl. Accessories	PPC-Pad-101	D28
	Hydraulic Tester PPC-Pad-102 with 2 CAN Networks and 3 Analog Sensor Inputs, incl. Accessories	PPC-Pad-102	D28
	Hydraulic Tester PPC-Pad-103 with 2 CAN Networks and 6 Analog Sensor Inputs, incl. Accessories	PPC-Pad-103	D28
<b>2. Hydraulic Tester PPC-Pad-SET</b>	Hydraulic Tester PPC-Pad-SET-101 with 2 CAN Networks, incl. Accessories, in Case with Cables	PPC-Pad-SET-101	D29
	Hydraulic Tester PPC-Pad-SET-102 with 2 CAN Networks and 3 Analog Sensor Inputs, incl. Accessories, in Case with Cables	PPC-Pad-SET-102	D29
	Hydraulic Tester PPC-Pad-SET-103 with 2 CAN Networks and 6 Analog Sensor Inputs, incl. Accessories, in Case with Cables	PPC-Pad-SET-103	D29
<b>3. Pressure Measurement</b> (for connecting and extension cables for Measuring Transmitters, see point 6)	<b>Pressure Transmitter G 1/2 (without Connecting Cable) for CAN Networks</b>		
	Pressure range from -1 ... 16 bar / -14.5 ... 232 PSI relative pressure	PPC-CAN-PT-016	D33
	Pressure range from 0 ... 60 bar / 0 ... 870 PSI absolute pressure	PPC-CAN-PT-060	D33
	Pressure range from 0 ... 160 bar / 0 ... 2321 PSI absolute pressure	PPC-CAN-PT-150	D33
	Pressure range from 0 ... 400 bar / 0 ... 5801 PSI absolute pressure	PPC-CAN-PT-400	D33
	Pressure range from 0 ... 600 bar / 0 ... 8702 PSI absolute pressure	PPC-CAN-PT-600	D33
	Pressure range from 0 ... 600 bar / 0 ... 8702 PSI absolute pressure **	PPC-CAN-PT-601	D33
	<b>Connection Adaptors</b>		
	Adaptor G 1/2 to M16 x 2 (STAUFF Test 20)	SDA20-G1/2-C6F	D33
	Adaptor M 16 x 2 to M16 x 1,5 (STAUFF Test 20 to STAUFF Test 15)	SAD20/15-P-C6F	D33
Adaptor M 16 x 2 to S12,65 x 1,5 (STAUFF Test 20 to STAUFF Test 12)	SAD20/12-P-C6F	D33	
Adaptor M 16 x 2 to plug-in (STAUFF Test 20 to STAUFF Test 10)	SAD20/10-P-C6F	D33	
<b>4. Flow Measurement</b> (for connecting and extension cables for measuring transmitters, see point 6)	<b>SFM Flow Meters with Integrated Signal Converter</b>		
	Measuring range from 1 ... 15 l/min / .3 ... 3.9 US GPM	PPC-CAN-SFM-015	D34
	Measuring range from 4 ... 60 l/min / 1 ... 15.9 US GPM	PPC-CAN-SFM-060	D34
	Measuring range from 6 ... 150 l/min / 1.6 ... 39.6 US GPM	PPC-CAN-SFM-150	D34
	Measuring range from 10 ... 300 l/min / 2.7 ... 79 US GPM	PPC-CAN-SFM-300	D34
Measuring range from 20 ... 600 l/min / 5.3 ... 158 US GPM	PPC-CAN-SFM-600	D34	
<b>5. Miscellaneous measurements</b>	Frequency Converter (PPC-Pad only)	PPC-CAN-FR	D35
<b>6. Connecting Cables for Measuring Transmitters with CAN Connection for CAN Networks</b>	Connecting Cable 0,5 m / 1.64 ft CAN Connection	PPC-CAN-CAB0.5	D35
	Connecting Cable 2 m / 6.65 ft CAN Connection	PPC-CAN-CAB2	D35
	Connecting Cable 5 m / 16.40 ft CAN Connection	PPC-CAN-CAB5	D35
	Connecting Cable 10 m / 32.81 ft CAN Connection	PPC-CAN-CAB10	D35
	Connecting Cable 10 m / 65.62 ft CAN Connection	PPC-CAN-CAB20	D35
	Y-splitter incl. 0,3 / .98 ft CAN Connection	PPC-CAN-CAB-Y	D35
CAN Terminating Resistor	PPC-CAN-R	D35	
<b>9. PC Connection and Software</b>	PC Software and PC Adaptor for PPC-04/2 (RS-232 connection)	PC-SET PPC-04-SW-CAB	D35
	PC Software and USB Connection lead for PPC-06/08-plus	PC-SET PPC-06/08-plus-SW-CAB	D35
	Adaptor Cabel RS-232 to USB for PPC	PPC-04/12-RS232-to-USB-CAB	D35
<b>10. Accessories and Spare Parts</b>	PPC-Pad Case (with individual insert)	PPC-Pad case	D29

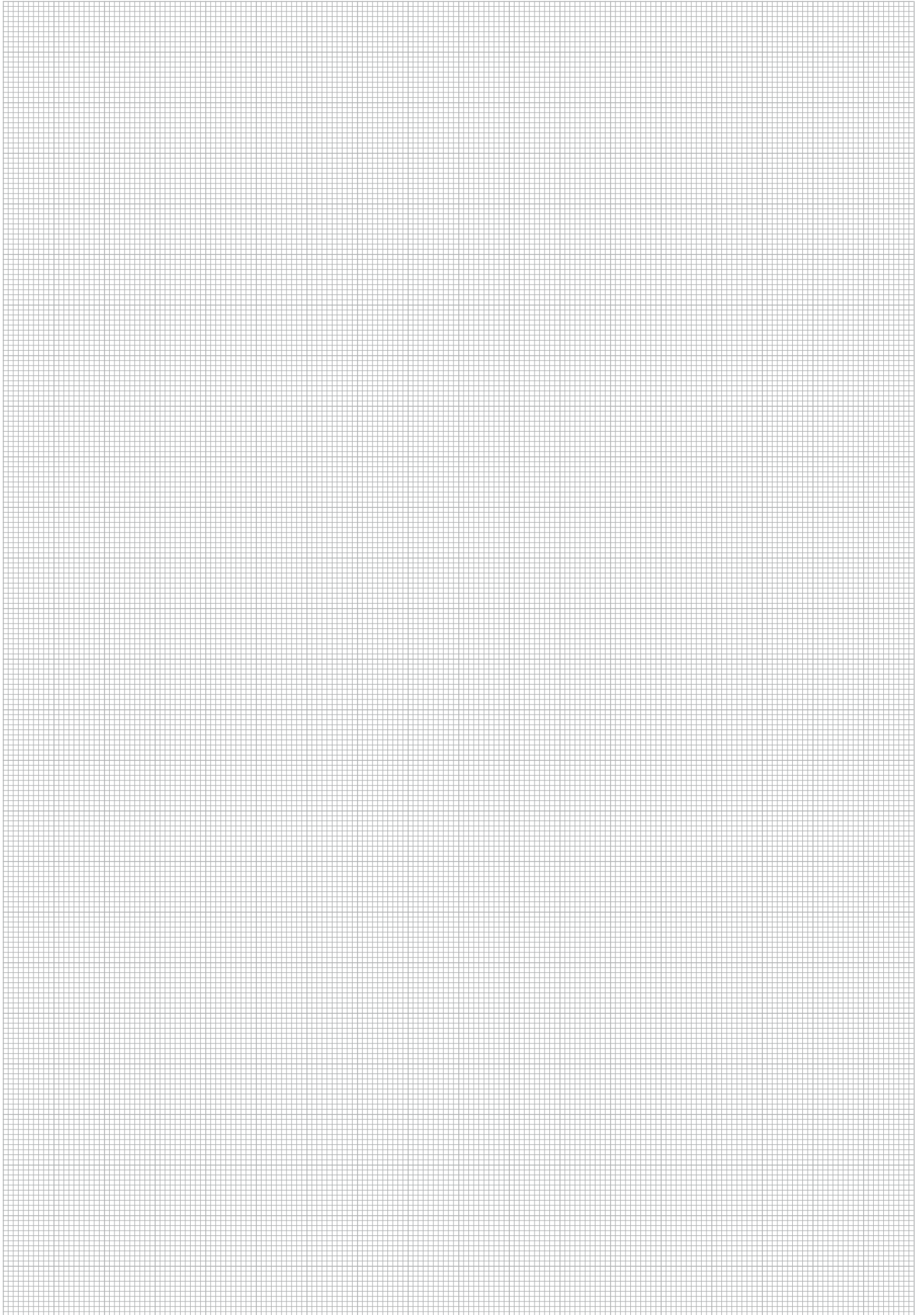

## Laser Particle Counter - Type LasPaC II



Fluid analysis is a crucial component of any oil management program. Early detection of potential problems can prevent costly repairs and downtime. The LasPaC II makes it possible to detect the ISO Cleanness levels of the hydraulic media.

### Characteristics

The LasPaC II devices feature a twin laser system and eight channels for different particle sizes in order to guarantee high accuracy and repeatability. These compact units are easy to handle for mobile and inline applications for systems with pressures up to 400 bar / 5801 PSI.

The LasPaC II is available in three different versions:

#### LasPaC II-P: Portable Laser Particle Counter

The LasPaC II-P is a fully equipped portable laser particle counter.

The LasPaC II-P features a complete QWERTY keyboard, an integrated thermal printer, an internal rechargeable battery and a large LCD display.

#### LasPaC II-M: Mobile Laser Particle Counter

The LasPaC II-M is a highly accurate laser particle counter.

With a competitive price, the LasPaC II-M is the best compromise between lower cost and brilliant accuracy/reliability.

#### LasPaC II-I: Inline Laser Particle Counter

The LasPaC II-I is a laser particle counter, which is suitable for all applications where continuous monitoring is required.

All LasPaC II devices have an internal data memory and are available within the accompanying Windows® based software package for reports and data downloads.

## Overview

Options	LasPaC II-P (Portable)	LasPaC II-M (Mobile)	LasPaC II-I (Inline)	Bottle Sampler 110	Bottle Sampler 250
Laser Type	Twin-Laser	Twin-Laser	Twin-Laser	-	-
Analysis Range	8 channels (4,6,14,21,25,38,50,68 μm <sub>eq</sub> )	8 channels (4,6,14,21,25,38,50,68 μm <sub>eq</sub> )	8 channels (4,6,14,21,25,38,50,68 μm <sub>eq</sub> )	-	-
Power Supply	External	External	External	-	-
Battery Option	Internal	External (optional)	-	-	-
Display	Integrated (large)	Integrated (small)	External (optional)	-	-
Keyboard	Integrated	-	-	-	-
Printer	Integrated	-	-	-	-
Data Storage	Internal (for approximately 600 tests)	Internal (for approximately 600 tests)	Internal (for approximately 600 tests)	-	-
Computer Interface	RS-232	RS-232	RS-232 (RS 485 on request)	-	-
Fluid Preparation	-	-	-	Integrated vacuum/pressure pump	Integrated vacuum/pressure pump
Maximal Bottle Size	-	-	-	110 ml	250 ml
Compatible with	-	-	-	Mineral oil and petroleum based fluids	Mineral oil and petroleum based fluids or phosphate ester
Sample-taking Equipment	-	-	-	Fluid sample pump with hoses	-

## Laser Particle Counter - Type LasPaC II

### Features & Options: LasPaC II (General)

#### Mobile - Compact and Convenient

The LasPaC II-P (Portable), the LasPaC II-M (Mobile) and all its accessories are supplied in a light-weight rugged industrial case.

This user-friendly portable case is waterproof and resistant against all common fluids.

#### Accuracy - Twin-laser, 100% Coverage

In all STAUFF laser particle counting devices, the fluid passes through the measuring cell and through a laser beam. The light from the laser is evaluated by a photo diode.

As the fluid passes through the laser beam the amount of light changes. These changes are directly proportional to size of the particles, and the total volume of particles. In many other particle counters only part of the measuring cell is lighted by the laser, thus only a part of the total amount of particles are registered, and the result is projected.

In contrast, the measuring cell of the LasPaC II is completely examined, and all particles are registered. In addition to this, a second laser is used to analyze all particles sizes smaller than  $6 \mu\text{m}_{\text{eq}}$ .

Additionally, the integrated booster cylinder allows very precisely dosage of the test fluids. This ensures a very high accuracy with excellent repeatability.

#### Functional - Calibration to ISO 11 171

The LasPaC II devices are calibrated with ISO Medium Test Dust (MTD) based on the ISO 11 171:1999 calibration standard.

STAUFF particle counters meet the new ISO 4406 cleanliness classification codes and provide results in the NAS 1638 and the SAE 4059 codes.

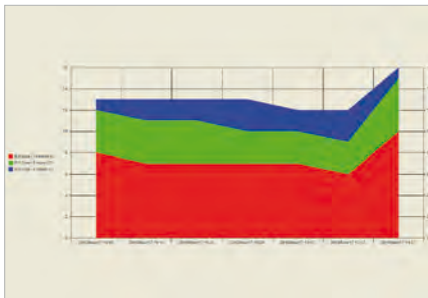

#### For any Type of Application - Large Pressure Range

A big advantage of the LasPaC II devices is the wide pressure range: Low pressure measurements starting with 2 bar / 29 PSI and high pressure tests up to 400 bar / 5801 PSI result in reliable readings. Many other products available today require special add-on devices or pressure cartridges which need to be recharged for this.

The test hoses, which are provided with the device, allow an easy connection to common test couplings M16 x 2 (STAUFF TEST 20 or comparable).

These units are also available for use with Phosphate Ester (e.g. Skydrol®) and Water Glycol fluids. Please contact STAUFF for details.

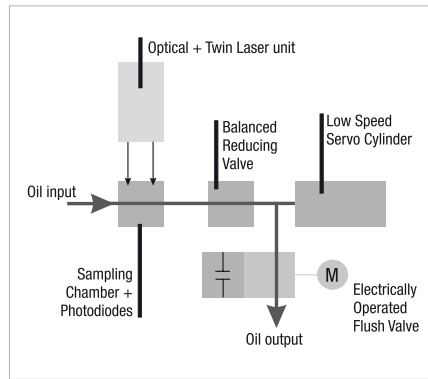

#### Global Use - Variable Voltage Supply

The external power supply unit provides most variable voltage ranges of 110 ... 240 V AC. European, UK and US plug adapters ensure a worldwide applicability of the LasPaC II.

#### Always Secure - External Alarms

The LasPaC II-P and LasPaC II-I devices offer the opportunity to define different alarm levels.

It is possible to configure two separate contamination alarm levels (e.g. clean alarm level and dirt alarm level). When set, an alarm indicator is given to external devices (e.g. indicator light, offline-filter) if the alarm level is reached.

#### Making the Connection -

##### Downloading with RS-232 Interface and USB Adaptor

The measured data can be downloaded onto any PC or laptop computer via the RS-232 interface or alternatively via a USB adaptor.

The LasPaC II software supports an easy download for data processing of the recorded measurements.

Several diagrams are available and are automatically generated to offer a very clear arrangement of all data for analysis. Data can also be easily exported to Microsoft Excel®.

#### Always up-to-date - Integrated Clock

An integrated rechargeable battery-operated clock provides the exact date and time which are shown on every printout.

In addition, every download of measured data is marked with date and time as well. The precise time of measurement is documented on all printouts and for all data stored.

#### Adaptable - Software Updates

The RS-232 (or USB) interface ensures flexibility for future developments in terms of calibration, evaluation and output. Software updates can easily be installed onto the LasPaC II devices.



#### Cleanliness - High-Speed Flush Valve

To ensure an accurate measurement is taken, the sensor must be cleaned before each test.

The LasPaC II achieves this by means of an electric operated flush valve. This valve can be opened on demand and between tests by simply depressing the flushing valve push button. The optimized design of the flush valve reduces the rinsing process to the minimum requirement, and ensures a quick restart of the next measurement.

#### For all Applications - High Compatibility

The LasPaC II units are compatible with all Mineral Oil and Petroleum based fluids. Phosphate Ester (e.g. Skydrol®) and Water Glycol compatible devices are available upon request. Please contact STAUFF for details.

#### More Oil Information - The Moisture/ Temperature Sensor

The LasPaC II also offers the option of adding an integral moisture / temperature sensor.

This sensor measures the moisture content of the test fluids (displayed as relative humidity in RH %) and also indicates the current fluid temperature (in °C).

Please note that the moisture/ temperature sensor is not compatible with Phosphate Ester (e.g. Skydrol®) and Water Glycol fluids. Please contact STAUFF for details.

#### Optional - Bottle Sampling Unit

Highly aerated fluids may lead to inaccurate results.

Therefore a de-aeration facility has been incorporated into the optional bottle sampling units.

Both sizes (110 ml and 250 ml) of the bottle sampling unit are delivered with an external power supply, and allow the user to properly condition the sample fluid prior to any measurements taken.

Please note that the moisture/ temperature sensor as mentioned above does not work in conjunction with the bottle sampling unit.

### Scope of Delivery

**Each kit of a laser particle counter STAUFF LasPaC II includes:**

- 1x Laser particle counter STAUFF LasPaC II
- 1x LasPaC II-M / LasPaC II-P: Waste hose 2 m / 3.65 ft  
LasPaC II-I: Waste hose 1,5 m / 2.67 ft
- 1x Pressure hose: 1,5 m / 2.67 ft
- 1x Waste bottle (not with LasPaC II-I)
- 1x External power supply including cable with European, UK and USA plug adaptors
- 1x RS-232 connecting cable, 1 m / 1.78 ft including RS-232 to USB converter
- 1x Software CD "LasPaC II View"
- 1x User guide LasPaC II
- 1x User guide LasPaC II View
- 3x Thermal printer paper (only with LasPaC II-P)

**Laser Particle Counter - Type LasPaC II-P (Portable)**



Light-Weight Rugged Industrial Case



Integrated Printer

**Product Description**

The LasPaC II-P (Portable) is the most complete way to measure the contamination level of your system. With the LasPaC II-P you have the ability to measure, analyze and document your results immediately without the need of any additional equipment.

**Features**

**Quick Results - Fast Results and Easy Operation**  
The integrated complete QWERTY keyboard, a large LCD display and intuitive handling all lead to the easy and quick operation of the LasPaC II Portable. The optimized flushing process of the LasPaC II-P is quick and effective, and allows for continuously accurate measurements.

**Black and White - Integrated Printer**  
The integrated printer in the LasPaC II-P supports print-outs in the field, thus providing immediate documentation. Every printout confirms date and time of your measurement.

**Independent Use - Rechargeable Battery Mode**  
The integrated rechargeable battery of the LasPaC II-P allows the use of on site measurements, even in the event where access of an external power source is not available. The measurement data is stored in the internal memory of the unit and can be transferred to a computer when required.

Once charged the LasPaC II-P can run approximately 100 tests before recharging is needed again.

**Options**

- Moisture results as relative humidity (RH %), temperatures in °C
- Phosphate Ester (e.g. Skydrol®) or specific Water Glycol fluids units on request

**Order Codes**

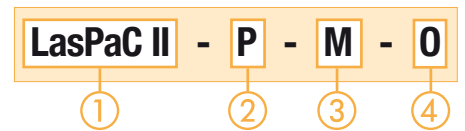

① **Series and Types**

Laser Particle Counter	LasPaC II
------------------------	-----------

② **Version**

Portable	P
----------	---

③ **Fluid Compatibility**

Mineral Oil, Petroleum based fluids (standard option)	M
Phosphate Ester (e.g. Skydrol®)	E
Specific Water Glycol fluids	G

④ **Moisture/ Temperature Sensor**

Without moisture/ temperature sensor	O
With moisture/ temperature sensor	W

Please note: The moisture/ temperature sensor is not suitable for Phosphate Ester (e.g. Skydrol®) and Water Glycol fluids.



## Laser Particle Counter ■ Type LasPaC II-P (Portable)



Highspeed Flush Valve



Computer Interfaces of the LasPaC II-P



Easy Connection to common Test Couplings

## Technical Data

**Dimensions and Weight**

- L/W/H: 551 x 358 x 226 mm / 21.69 x 14.09 x 8.90 in
- Weight: 13 kg / 28.66 lbs

**Keyboard / Printer**

- Keyboard: QWERTY keyboard
- Printer: Integrated thermal printer (384 dots per line)

**Power Supply**

- Voltage range: 110 ... 240 V AC  
12 ... 24 V DC
- European, UK and US power plug adaptors included
- Number of tests before recharging is required: 100

**Calibration**

- Calibration: ISO Medium Test Dust (MTD) according to ISO 11 171:1999
- Analysis range: ISO 8-24, ISO 4406 Code, NAS 1638 Code 2-12, SAE AS 4059 Code 2-12

**Pressure / Viscosity**

- Pressure range: 2 ... 400 bar / 29 ... 5801 PSI
- Viscosity range: up to 400 cSt

**Laser Sensors**

- High accuracy laser: 4 ... 6  $\mu\text{m}_{(e)}$
- Standard accuracy laser: 6 ... 68  $\mu\text{m}_{(e)}$
- Measured channels: 4, 6, 14, 21, 25, 38, 50, 68  $\mu\text{m}_{(e)}$
- The orifice of the sensor has a cross section of 0,9 x 0,9 mm / .04 x .04 in
- The maximum concentration is ISO 4406 Code 24 (160.000 p/ml)

**Accessories**

- Bottle sampling unit: 110 ml version (only for Mineral Oil and Petroleum based fluids)  
250 ml version (for Mineral Oil and Petroleum based fluids; a Phosphate Ester (e.g. Skydrol®) compatible version of the 250 ml unit is available on request.)  
Please contact STAUFF for details
- Screen filter: Screen filter (500  $\mu\text{m}$ )

**Connections**

- Hose connections: Test coupling STAUFF Test 20 or comparable (M16 x 2)

**Sample Volume**

- 8 ml (short)
- 15 ml (normal)
- 30 ml (dynamic)
- 24 ml (bottle sampler)
- 15 ml (continuous)

**Permissible Temperature**

- Operating: +5 °C ... +80 °C / +41 °F ... +176 °F

**Data Output**

- Cumulative particle counts, as well as cleanliness classes according to ISO 4406 (1999) / SAE AS 4059 Rev.D (2001) and ISO 4406 (1191) / NAS 1638 (1964)

**Max. Concentration**

- ISO 24

**Accumulator**

- Internal rechargeable battery

**Data Storage**

- 600 tests

**Fluid Compatibility**

- Mineral Oil, Petroleum based fluids
- Phosphate Ester and Water Glycol compatible devices on request

**Computer Interface**

- RS-232 communication port as standard
- USB adaptors included

**External Alarm**

- External alarm socket with switching outputs  
max. 24 V DC/AC, 1 A

**Software**

- Downloading and storage of the data with included "LasPaC II View" software. Further processing with Microsoft Excel® possible.

## Laser Particle Counter - Type LasPaC II-M (Mobile)



External Battery Pack for the LasPaC II-M

### Product Description

The LasPaC II-M (Mobile) is designed for applications where it is necessary to have a small, light and robust service unit.

### Features

#### Versatile - Lightweight and Convenient

In comparison to the LasPaC II-P, the LasPaC II-M is a more simplified particle counter.

The LasPaC II-M offers the same measurement opportunities (excellent accuracy, repeatability and reliability) but does not include the integrated printer, the complete QWERTY keyboard, the large LCD display, or the internal rechargeable battery.

#### Low Cost - Same Functions for a Budget Price

Without losing the quality in measurement accuracy, reliability and repeatability the LasPaC II-M is a cost effective alternative to the fully equipped LasPaC II-P.

### Options

- Moisture results as relative humidity (RH %), temperatures in °C
- Phosphate Ester (e.g. Skydrol®) or specific Water Glycol fluids units on request

Because the LasPaC II-M does not have the internal rechargeable battery, the unit will need to be connected to a power supply to operate.

### Accessory

#### On the Move - External Battery Pack

For the LasPaC II-M an external battery pack is available as an option.

This ensures a measurement for applications where no power supply can be connected.

The battery pack can be recharged in your car or with an external power supply.

### Order Codes

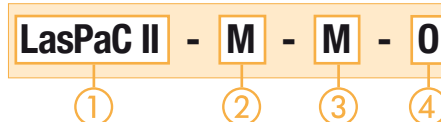

#### ① Type and Series

Laser Particle Counter	LasPaC II
------------------------	-----------

#### ② Version

Mobile	M
--------	---

#### ③ Fluid Compatibility

Mineral Oil, Petroleum based fluids (standard option)	M
Phosphate Ester (e.g. Skydrol®)	E
Specific Water Glycol fluids	G

#### ④ Moisture/ Temperature Sensor

Without moisture/ temperature sensor	0
With moisture/ temperature sensor	W

Please note: The moisture/ temperature sensor is not suitable for Phosphate Ester (e.g. Skydrol®) and Water Glycol fluids.

## Laser Particle Counter ■ Type LasPaC II-M (Mobile)



LasPaC II-M with small Bottle Sampler



Display and Buttons

## Technical Data

**Dimensions and Weight**

- L/W/H: 340 x 295 x 152 mm /  
13.40 x 11.61 x 5.98 in
- Weight: 4,75 kg / 10.47 lbs

**Power Supply**

- Voltage range: 110 ... 240 V AC  
12 ... 24 V DC
- European, UK and US power plug adaptors included
- Number of tests before recharging is required: 100

**Calibration**

- Calibration: ISO Medium Test Dust (MTD)  
according to ISO 11 171:1999
- Analysis range: ISO 8-24, ISO 4406 Code,  
NAS 1638 Code 2-12,  
SAE AS 4059 Code 2-12

**Pressure / Viscosity**

- Pressure range: 2 ... 400 bar / 29 ... 5801 PSI
- Viscosity range: up to 400 cSt

**Laser Sensors**

- High accuracy laser: 4 ... 6  $\mu\text{m}_{(e)}$
- Standard accuracy laser: 6 ... 68  $\mu\text{m}_{(e)}$
- Measured channels: 4, 6, 14, 21, 25, 38, 50, 68  $\mu\text{m}_{(e)}$
- The orifice of the sensor has a cross section of  
0,9 x 0,9 mm / .04 x .04 in
- The maximum concentration is ISO 4406 Code 24  
(160.000 p/ml)

**Accessories**

- Bottle sampling unit: 110 ml version (only for Mineral  
Oil and Petroleum based fluids)  
250 ml version (for Mineral Oil  
and Petroleum based fluids;  
a Phosphate Ester (e.g. Skydrol®)  
compatible version of the 250 ml  
unit is available on request.)  
Please contact STAUFF for details.
- Screen filter: Screen filter (500  $\mu\text{m}$ )

**Connections**

- Hose connections: Test coupling STAUFF Test 20 or  
comparable (M16 x 2)

**Sample Volume**

- 8 ml (short)
- 15 ml (normal)
- 30 ml (dynamic)
- 24 ml (bottle sampler)
- 15 ml (continuous)

**Permissible Temperature**

- Operating: +5 °C ... +80 °C / +41 °F ... +176 °F

**Data Output**

- Cumulative particle counts, as well as cleanliness classes  
according to ISO 4406 (1999) / SAE AS 4059 Rev.D (2001)  
and ISO 4406 (1191) / NAS 1638 (1964)

**Max. Concentration**

- ISO 24

**Accumulator**

- External battery pack (optional)

**Data Storage**

- 600 tests

**Fluid Compatibility**

- Mineral Oil, Petroleum based fluids
- Phosphate Ester and Water Glycol compatible devices on  
request

**Computer Interface**

- RS-232 communication port as standard
- USB adaptors included

**Software**

- Downloading and storage of the data with included "LasPaC  
II View" software. Further processing with Microsoft Excel®  
possible.

## Laser Particle Counter - Type LasPaC II-I (Inline)



Front / Bottom View of the STAUFF LasPaC II-I

### Product Description

The LasPaC II-I (Inline) unit is designed for hydraulic applications, where continuous monitoring is essential. It is installed permanently in a hydraulic system.

Please note that the LasPaC II-I needs a minimum working pressure of 2 bar / 29 PSI for reliable particle counting.

The LasPaC II-I does not have the QWERTY keyboard, the LCD display, and an internal rechargeable battery.

All test results are saved in the integrated memory and can be downloaded to a PC or laptop computer with the RS-232 interface or USB adapter.

Also, the configuration of the LasPaC II-I has to be done with a PC or laptop computer.

### Features

#### Accessory - Remote Display

For a direct display of the measured data an optional remote display is available for the LasPaC II-I.

This device also offers the opportunity to flush the LasPaC II-I and to start and stop the measurement by use of the three push buttons.

The standard cable length of the remote display is 2 m / 6.56 ft.

A cable with a length of 5 m / 16.40 ft is available on request.

#### Hazard Conditions - Rugged Aluminium Case

The LasPaC II-I inline unit has a rugged, powder coated Aluminum case which can be easily installed, even in hazardous conditions.

### Options

- Moisture results as relative humidity (RH %), temperatures in °C
- Phosphate Ester (e.g. Skydrol®) or specific Water Glycol fluids units on request
- ATEX (Zone II Category 3G rating) is available. Contact STAUFF for more information.

### Order Codes



#### ① Series and Type

Laser Particle Counter	<b>LasPaC II</b>
------------------------	------------------

#### ② Version

Inline	<b>I</b>
--------	----------

#### ③ Fluid Compatibility

Mineral Oil, Petroleum based fluids (standard option)	<b>M</b>
Phosphate Ester (e.g. Skydrol®)	<b>E</b>
Specific Water Glycol fluids	<b>G</b>

#### ④ Computer Interface

RS-232 computer interface (standard option)	<b>232</b>
RS-485 computer interface	<b>485</b>

#### ⑤ Display Mode

PC driven (standard option)	<b>D3</b>
Remote module + PC driven	<b>D2</b>
Remote visual indicator (red/green) + PC driven	<b>D5</b>
Customer-specific display (e.g. Modbus)	<b>X</b>

#### ⑥ Moisture/ Temperature Sensor

Without moisture/ temperature sensor	<b>0</b>
With moisture/ temperature sensor	<b>W</b>

Please note: The moisture/ temperature sensor is not suitable for Phosphate Ester (e.g. Skydrol®) and Water Glycol fluids.

#### ⑦ Design Code

Inlet pressure: 2 ... 400 bar / 29 ... 5801 PSI	
Drain reservoir/system: Atmospheric, zero back pressure	<b>30</b>
Inlet pressure: 10 ... 400 bar / 145 ... 5801 PSI	
Drain reservoir/system: Back pressure not exceeding 1 bar / 14 PSI	<b>31</b>

## Laser Particle Counter ■ Type LasPaC II-I (Inline)



Rear / Top View of the STAUFF LasPaC II-I



Remote Display for the STAUFF LasPaC II-I

**Technical Data**
**Dimensions and Weight**

- LxWxH: 120 x 275 x 250 mm /  
4.72 x 10.83 x 9.84 in
- Weight: 4,80 kg / 10.58 lbs

**Power Supply**

- Voltage range: 110 ... 240 V AC  
12 ... 24 V DC
- European, UK and US power plug adaptors included
- Number of tests before recharging is required: 100

**Calibration**

- Calibration: ISO Medium Test Dust (MTD) according to ISO 11 171:1999
- Analysis range: ISO 8-24, ISO 4406 Code, NAS 1638 Code 2-12, SAE AS 4059 Code 2-12

**Pressure / Viscosity**

- Pressure range: Series 30: 2 ... 400 bar/  
29 ... 5801 PSI  
Series 31: 10 ... 400 bar/  
145 ... 5801 PSI
- Viscosity range: up to 400 cSt

**Laser Sensors**

- High accuracy laser: 4 ... 6 µm<sub>0</sub>
- Standard accuracy laser: 6 ... 68 µm<sub>0</sub>
- Measured channels: 4, 6, 14, 21, 25, 38, 50, 68 µm<sub>0</sub>
- The orifice of the sensor has a cross section of 0,9 x 0,9 mm / .04 x .04 in
- The maximum concentration is ISO 4406 Code 24 (160.000 p/ml)

**Accessories**

- Bottle sampling unit: 110 ml version (only for Mineral Oil and Petroleum based fluids)  
250 ml version (for Mineral Oil and Petroleum based fluids; a Phosphate Ester (e.g. Skydrol®) compatible version of the 250 ml unit is available on request.)  
Please contact STAUFF for details.
- Screen filter: Screen filter (500 µm)

**Connections**

- Hose connections: Test coupling STAUFF Test 20 or comparable (M16 x 2)

**Sample Volume**

- 8 ml (short)
- 15 ml (normal)
- 30 ml (dynamic)
- 24 ml (bottle sampler)
- 15 ml (continuous)

**Permissible Temperature**

- Operating: +5 °C ... +80 °C / +41 °F ... +176 °F

**Data Output**

- Cumulative particle counts, as well as cleanliness classes according to ISO 4406 (1999) / SAE AS 4059 Rev.D (2001) and ISO 4406 (1191) / NAS 1638 (1964)

**Max. Concentration**

- ISO 24

**Data Storage**

- 600 tests

**Fluid Compatibility**

- Mineral Oil / Petroleum based fluids
- Phosphate Ester and Water Glycol compatible devices on request

**Computer Interface**

- RS-232 communication port as standard
- RS-485 on request
- USB adaptors included

**Software**

- Downloading and storage of the data with included "LasPaC II View" software. Further processing with Microsoft Excel® possible.

**External Alarm**

- separate wires in connector cable ( max. 24 V DC/AC, 1A)

**Protection Rating**

- IP 55 protection rating: Dust protected and protected against water jets

**Laser Particle Counter - Type Bottle Sampler**



Bottle Sampling Unit 250 ml



Bottle Sampling Unit 110 ml



Bottle Sampling Unit 110 ml and Accessories

**Product Description**

**Analysis Everywhere - Bottle Sampling Unit**

If a direct particle count on your system is not possible, the LasPaC II bottle sampler units allow you to take measurement samples for analysis at a later time.

**Conditioning - The De-aeration Facility**

A highly aerated fluid may lead to inaccurate results; therefore a de-aeration process has been incorporated into the bottle sampling units.

By evacuating the air from the sampling chamber, aeration within the fluid is removed, and the fluid is properly conditioned prior to sampling.

**Your Choice - 110 ml or 250 ml Size**

STAUFF offers two sizes of bottle sampling units for the LasPaC II devices: the 110 ml and the 250 ml units.

The 110 ml unit is supplied in an extra case including various accessories such as power supply, sampling hoses, pressure hoses, bottles (sample and waste) and adapters. It is designed for mobile applications and is only compatible with Mineral Oil and Petroleum based fluids.

The standard version of the 250 ml unit is compatible with Mineral Oil and Petroleum based fluids; a Phosphate Ester (e.g. Skydrol®) compatible version of the 250 ml unit is available on request. Please contact STAUFF for details.

The 250 ml bottle sampling unit is delivered with the required power supply.

Please note that the moisture / temperature sensor does not work in combination with bottle sampler devices.

**Order Codes**

**LasPaC II - Bottle Sampler 110**

①

②

① **Type and Series**

Laser Particle Counter **LasPaC II**

② **Bottle Sampling Unit**

110 ml Bottle Sampling Unit suitable for Mineral Oil and Petroleum based fluids only	<b>Bottle Sampler 110</b>
250 ml Bottle Sampling Unit suitable for Mineral Oil and Petroleum based fluids only	<b>Bottle Sampler 250</b>
250 ml Bottle Sampling Unit suitable Phosphate Ester (e.g. Skydrol®)	<b>Bottle Sampler 250-E</b>

## Moisture / Temperature Sensor

### Product Description

**More Oil Analysis - Oil Saturation and Temperature**  
 In Mineral Oils and non-aqueous fire resistant fluids, water is undesirable. Once the water exceeds a saturation level (about 500 ppm for Mineral Oils) the fluid starts to appear hazy. Above this level there is a danger of free water accumulating in the system. This can lead to corrosion and accelerated wear.

As an option, all LasPaC II devices provide accurate and repeatable measurement of the saturation level of water in oil with the moisture / temperature sensor. The sensor is located internally in a specially designed housing and is positioned in the low pressure constant flow line.

**Simplicity - Saturation Level as a Percentage**  
 Different oils have different saturation levels. For this reason, measurements in % saturation is the best and most practical way. Of course these results can be converted to ppm (parts per million) if the oil type saturation / temperature characteristics are known.

**Additional Information - Oil Temperature Readings**  
 Beside the saturation level the optional moisture / temperature sensor of the LasPaC II units has the ability to measure the fluid temperature. This allows to provide a reference temperature for the RH (relative humidity / % saturation of water in oil) readings.

Both results, RH % and °C, are displayed on the main / test progress screen and on the printed analysis.

Please note: Due to the temperature gradient existing between the system tapping point and the RH / temperature module, the temperature reading can be 5° to 10° less than the actual system temperature, depending on operating conditions. The moisture / temperature sensor is not suitable for bottle sampling.

#### Saturation Levels

Since the effects of free (also emulsified) water are more harmful than those of dissolved water, water levels should remain always well below the saturation point.

However, even water in solution can cause damage, and therefore every reasonable effort should be made to keep saturation levels as low as possible.

There is no such thing as too little water. As a guideline, we recommend maintaining saturation levels below 50 % in all equipment.

Different oils have different saturation levels, and % saturation is the best and most practical measurement.

These results can be converted to ppm (parts per million), if the oil type saturation / temperature characteristic is known.

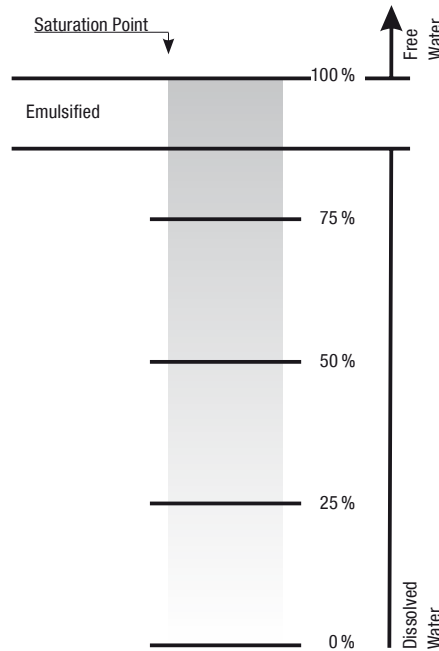

## Laser Particle Counter - Accessories



### Order Codes

## Accessories / Spare Parts

#### ① Type of Accessories / Spare Parts

Waste hose 2 m / 6.56 ft	LasPaC II - Waste hose 2m
Pressure hose 1,5 m / 4.92 ft	SMS-20-1500-A-C6F
100 ml certified clean bottle (5 pieces)	LasPaC II - Bottle 100-C Set
250 ml certified clean bottle (5 pieces)	LasPaC II - Bottle 250-C Set
100 ml glass sample bottle (5 pieces)	LasPaC II - Bottle 100 Set
250 ml glass sample bottle (5 pieces)	LasPaC II - Bottle 250 Set
Printer paper LasPaC II-P (5 pieces)	LasPaC II - P-Printer Paper Set
Battery pack LasPaC II-M	LasPaC II -M- Battery Pack
RS 232 to USB converter	Adapter PPC-04/12-RS232-to-USB-CAB
Screen filter	LasPaC II - Screen Filter

### Product Description: Screen Filter

An optional Screen Filter is available for heavily contaminated systems. The filter device is assembled directly to the supply line and allows particle counts in ambient conditions where normally the contamination is too high for a reliable test.

The Stainless Steel Filter has a mesh of 500 µm and is cleanable.

Laser Particle Counter - Technical Data

Type	LasPaC II-P (Portable)	LasPaC II-M (Mobile)	LasPaC II-I (Inline)
<b>Dimensions (mm/in)</b> (W x D x H)	551 x 358 x 226 21.69 x 14.09 x 8.90	340 x 295 x 152 13.40 x 11.61 x 5.98	120 x 275 x 250 4.72 x 10.83 x 9.84
<b>Weight (kg/lbs)</b>	13 28.66	4,75 10.47	4,80 10.58
<b>Keyboard</b>	QWERTY keyboard integrated	-	-
<b>Printer</b>	Thermal printer integrated (384 dots per line)	-	-
<b>Viscosity Range</b>	1 ... 400 cSt	1 ... 400 cSt	1 ... 400 cSt
<b>Calibration</b>	MTD, ISO 11 171:1999	MTD, ISO 11 171:1999	MTD, ISO 11 171:1999
<b>Analysis Range</b>	ISO 8-24, ISO 4406 Code, NAS 1638 Code 2-12, SAE AS 4059 Code 2-12	ISO 8-24, ISO 4406 Code, NAS 1638 Code 2-12, SAE AS 4059 Code 2-12	ISO 8-24, ISO 4406 Code, NAS 1638 Code 2-12, SAE AS 4059 Code 2-12
<b>Sensitivity</b>	4, 6, 14, 21, 25, 38, 50, 68 µm <sub>(c)</sub>	4, 6, 14, 21, 25, 38, 50, 68 µm <sub>(c)</sub>	4, 6, 14, 21, 25, 38, 50, 68 µm <sub>(c)</sub>
<b>Sample Volume</b>	8 ml (short) 15 ml (normal) 30 ml (dynamic) 24 ml (bottle sampler) 15 ml (continuous)	8 ml (short) 15 ml (normal) 30 ml (dynamic) 24 ml (bottle sampler) 15 ml (continuous)	8 ml (short) 15 ml (normal) 30 ml (dynamic) 24 ml (bottle sampler) 15 ml (continuous)
<b>Pressure Range (bar/psi)</b>	2 ... 400 29 ... 5801	2 ... 400 29 ... 5801	Series 30: 2 ... 400 29 ... 5801 Series 31: 10 ... 400 145 ... 5801
<b>Operating Temperature (°C/°F)</b>	+5 ... +80 +41 ... +176	+5 ... +80 +41 ... +176	+5 ... +80 +41 ... +176
<b>Max. Concentration</b>	ISO 24	ISO 24	ISO 24
<b>Power Supply</b>	110 ... 240 V AC 12 ... 24 V DC	110 ... 240 V AC 12 ... 24 V DC	110 ... 240 V AC 12 ... 24 V DC
<b>Accumulator</b>	Internal rechargeable battery	External battery pack (optional)	-
<b>Data Storage</b>	600 tests	600 tests	600 tests
<b>Fluid Compatibility</b>	Mineral Oil / Petroleum based fluids; Phosphate Ester and water glycol compatible devices on request	Mineral Oil / Petroleum based fluids; Phosphate Ester and Water Glycol compatible devices on request	Mineral Oil / Petroleum based fluids; Phosphate Ester and Water Glycol compatible devices on request
<b>Computer Interface</b>	RS-232	RS-232	RS-232
<b>External Alarm</b>	External alarm socket	-	Signal in connector cable
<b>Hose Connections</b>	Test coupling STAUFF Test 20 or comparable (M16 x 2)	Test coupling STAUFF Test 20 or comparable (M16 x 2)	Test coupling STAUFF Test 20 or comparable (M16 x 2)
<b>Accessories</b>	Moisture/temperature sensor Bottle sampling unit (110 ml / 250 ml) Screen filter (500 µm)	Moisture/temperature sensor Bottle sampling unit (110 ml / 250 ml) Screen filter (500 µm)	Moisture/temperature sensor Bottle sampling unit (110 ml / 250 ml) Screen filter (500 µm)



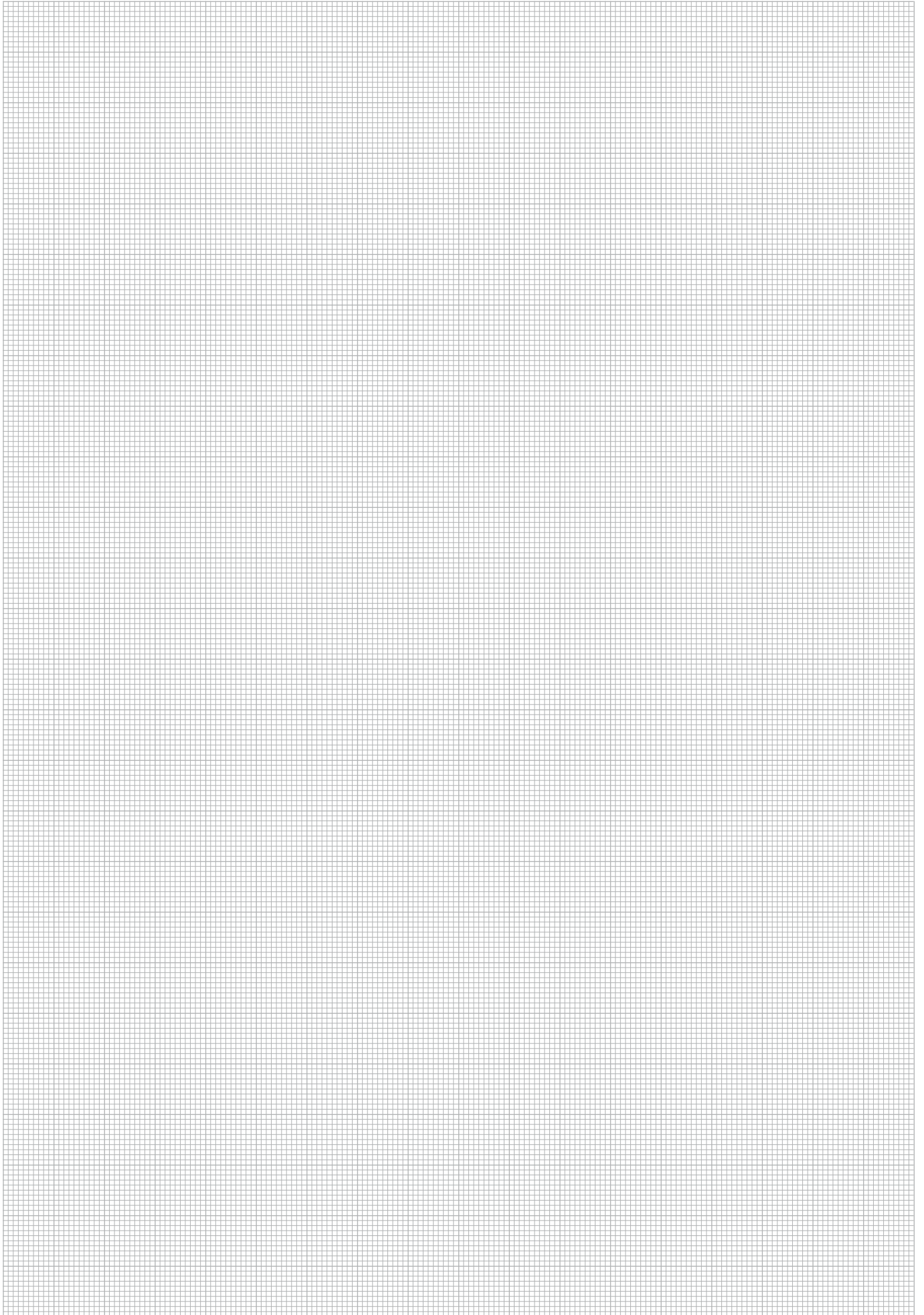

## Laser Particle Monitor - Type LPM-1

### Product Description



The Laser Particle Monitor System LPM-1 is a laser based 4-channel inline particle monitor designed for the continuous monitoring of particle contamination. The LPM-1 provides cumulative particle concentration information at  $>4 \mu\text{m}_{(0.1)}$ ,  $>6 \mu\text{m}_{(0)}$  and  $>14 \mu\text{m}_{(0)}$  sizes applicable to the ISO 4406, ISO 11943 und ISO 11171 requirements for optical particle counters. A  $> 21 \mu\text{m}_{(0)}$  channel is also provided for larger particle concentration information. Machine operators are alerted to changes in particle contamination levels in a machine's fluid by the indications provided from the LPM-1.

The contamination level can be shown on the display or can be transmitted via the RS-232 serial port to a personal computer. With the ModBus-serial port the data can be transferred into a computer network or to an external display. The LPT Particle Transducer is configured via the IR-port on a Palm. The LPM-1 system consists of a Laser Particle Transducer LPT and a Laser Interface Module LIM.

### Functional diagram

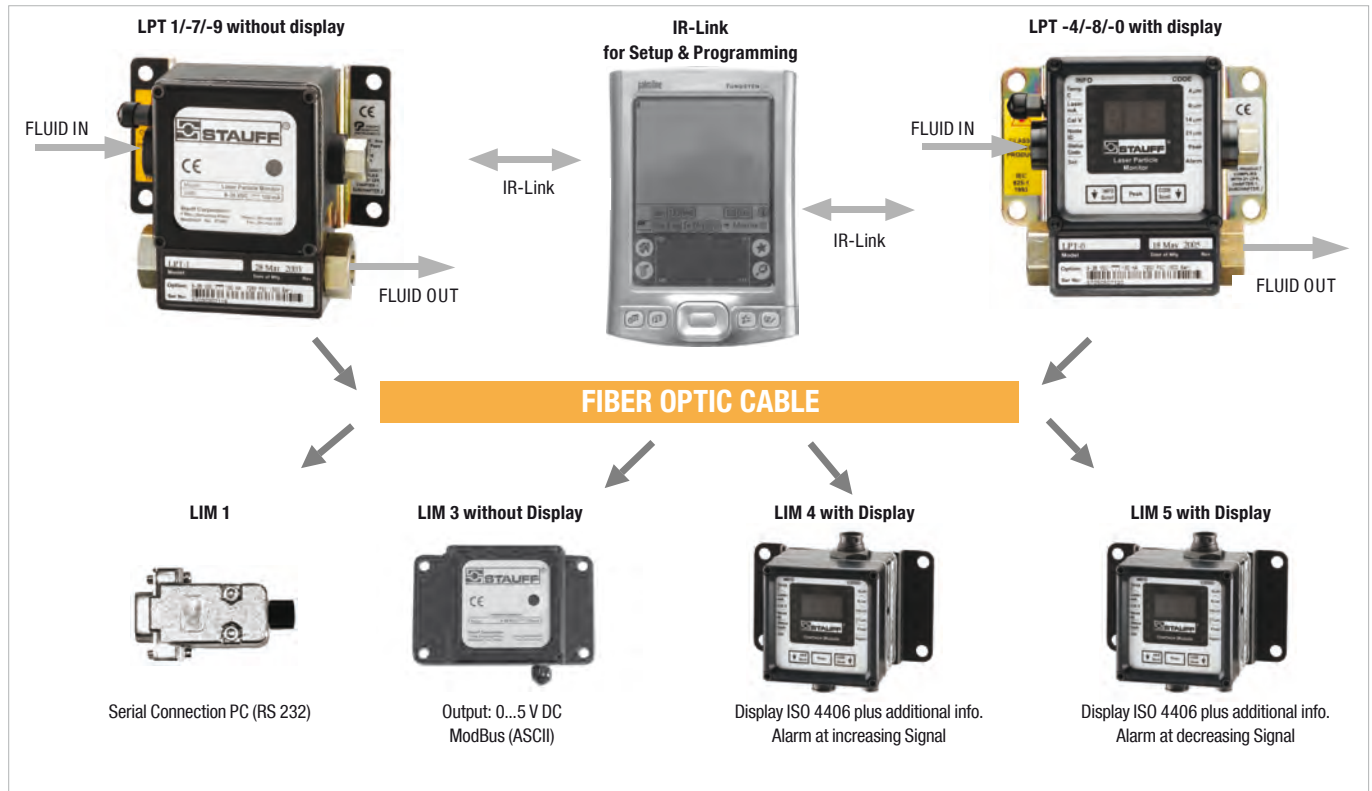

### Order Codes

**LPM-1 - T1 - M4 - DAV**

①                      ②                      ③                      ④

#### ① Series and Type

Laser Particle Monitor **LPM-1**

#### ② Laser Particle Transducer (LPT)

Without LPT	<b>0</b>
LPT-1; 28 ... 500 bar / 400 ... 7250 PSI; without display	<b>T1</b>
LPT-4; 28 ... 500 bar / 400 ... 7250 PSI; with display	<b>T4</b>
LPT-7; 3,4 ... 83 bar / 50 ... 1200 PSI; without display	<b>T7</b>
LPT-8; 3,4 ... 83 bar / 50 ... 1200 PSI; with display	<b>T8</b>
LPT-9; 1,4 ... 13,8 bar / 20 ... 200 PSI; without display	<b>T9</b>
LPT-0; 1,4 ... 13,8 bar / 20 ... 200 PSI; with display	<b>T0</b>

#### ③ Laser Interface Module (LIM)

Without LIM	<b>0</b>
LIM-1; PC connection RS-232 serial port	<b>M1</b>
LIM-3; 8-channel (0 V ... 5 V DC) output, Modbus PC connection RS-485 serial port	<b>M3</b>
LIM-4; LED display with alarm contacts (for exceeding the set alarm level)	<b>M4</b>
LIM-5; LED display with alarm contacts (for falling below the set alarm level)	<b>M5</b>

#### ④ Dynamic Application Valve (DAV)

Without Dynamic Application Valve	<b>0</b>
Dynamic Application Valve	<b>DAV</b>

### Scope of Delivery

Each kit of LPM-1 includes:

- 1x Laser Particle Transducer LPT (optional)
  - includes 3 m / 9.84 ft flying lead power cable (9 ... 36 V DC required, not supplied)
- 1x Laser Interface Module LIM (optional)
  - LIM-1, includes 6 m / 19.69 ft interconnecting fiber optic cable
  - LIM-3, includes 6 m / 19.69 ft interconnecting fiber optic cable and two 3 m / 9.84 ft power cable with 3-Pin connector
  - LIM-4, includes 6 m / 19.69 ft interconnecting fiber optic cable and one breakout cable with 15-Pin connector
  - LIM-5, includes 6 m / 16.69 ft interconnecting fiber optic cable and one breakout cable with 15-Pin connector
- 1x Quick Start Guide
- 1x Operating Manual
- 1x Software
  - includes DDE server
  - hex and terminal logger for RS-232
  - Palm shareware

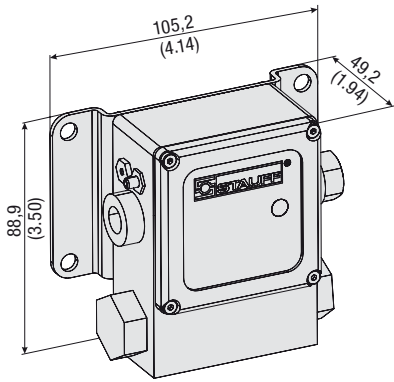
**Laser Particle Transducer ■ Type LPT-1**

Laser Particle Transducer LPT-1/-7/-9 without display.

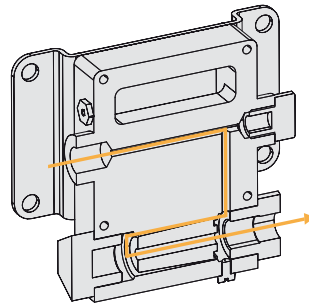

Flow Pattern

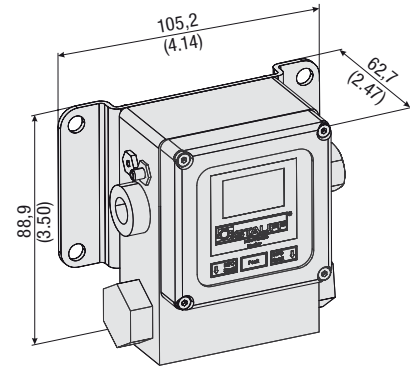

Laser Particle Transducer LPT-4/-8/-0 with display.

**Technical Data**
**Channel Sizes**

- 4, 6, 14 and 21  $\mu\text{m}_{\text{eq}}$  (ISO MTD/ISO 11171)

**Light Source**

- Laser diode

**Sampling**

- Continuous online monitoring

**Reproducibility**

- $\pm 0.5$  ISO code (ISO 4406)

**Display**

- Optional local display available; presents ISO codes and alarms

**Power Supply**

- 9 ... 36 V DC @ 150 mA (power must be supplied to instrument for operation)

**Electrical Data and Output**

- RS-232; RS-485
- 0 ... 5 V DC
- Modbus
- Alarms
- Local and remote displays

**Reports**

- Particles/ml; ISO 4406 codes 4, 6, 14 and additional 21  $\mu\text{m}_{\text{eq}}$  (ISO MTD/ISO 11171)

**Process Connections**

- SAE-4 (7/16–20 UNF)

**Sensor Flow Rate**

- 50 ... 500 ml/min (0.01 ... 0.1 US GPM) through the viewing area. All units offer integrated flow rate monitoring with alarms.

**Media Compatibility**

- Suitable for mineral based hydraulic and lubrication oils; compatibility with synthetic media (Phosphate Ester) on request

**Viscosity**

- 2 ... 424 cSt at ambient temperature of  $+25^\circ\text{C} \pm 2^\circ\text{C} / +77^\circ\text{F} \pm 3.6^\circ\text{F}$

**Operating Pressure**

- 1,4 bar ... 500 bar / 20 PSI ... 7250 PSI

**Permissible Temperature**

- Storage:  $-40^\circ\text{C} \dots +85^\circ\text{C} / -40^\circ\text{F} \dots +185^\circ\text{F}$
- Ambient:  $-20^\circ\text{C} \dots +60^\circ\text{C} / -4^\circ\text{F} \dots +140^\circ\text{F}$
- Operating:  $-10^\circ\text{C} \dots +60^\circ\text{C} / +14^\circ\text{F} \dots +140^\circ\text{F}$

**Protection Rating**

- IP 67 protection rating: Dust tight and protected against powerful water jets; even immersion (up to 1 m / 3.28 ft) in water is possible under defined conditions of pressure and time

**Product Description**

The Laser Particle Transducer (LPT) contains the sensing device and electronics for detecting the level of contamination.

The laser based sensor uses light blocking technology for particle detection whereby particles passing through an optical flow cell block an amount of laser light proportional to the particle size.

The resultant particle concentration data from the Laser Particle Transducer (LPT) are sent to the Laser Interface Module (LIM) via a fibre optic cable. The configuration of the Laser Particle Transducer (LPT) has to be done through the IrDA port of any Palm with IRA capabilities.

The Laser Particle Transducer (LPT) has a flow inhibitor downstream of the sensor that restricts and controls the fluid flow for any stable pressure within the models specified flow range. For use with a dynamic or changing inlet pressure, please use the additional Dynamic Application Valve (DAV, please see on page D52).

The pressure is reduced to near atmospheric for return to the hydraulic reservoir. The inlet pressure ranges from 1,4 bar to 500 bar / 20 PSI to 7250 PSI in three models.

The Laser Particle Transducer (LPT) is optionally available with or without a LED display.

The three digit display shows the selected ISO code value or other function parameters.

**The following types of Laser Particle Transducers (LPT) are available:**

- **LPT-1** 28 ... 500 bar (400 ... 7250 PSI), without LED display
- **LPT-4** 28 ... 500 bar (400 ... 7250 PSI), with LED display
- **LPT-7** 3,4 ... 83 bar (50 ... 1200 PSI), without LED display
- **LPT-8** 3,4 ... 83 bar (50 ... 1200 PSI), with LED display
- **LPT-9** 1,4 ... 13,8 bar (20 ... 200 PSI), without LED display
- **LPT-0** 1,4 ... 13,8 bar (20 ... 200 PSI), with LED display

## Laser Interface Module - Type LIM

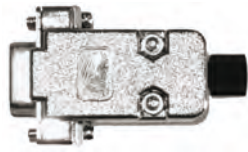

Laser Interface Module LIM-1



Laser Interface Module LIM-3



Laser Interface Module LIM-4 and LIM-5

### Product Description

The LIM converts the raw count data from the LPT for display or use in acquisition, logging or control systems. A terminal emulation program can be used to read the ASCII data string. The LIM is available in four types to meet a wide variety of applications. LPT and LIM are connected via a fibre optic cable with a length up to 50 m / 164.04 ft.

#### LIM-1

The LIM-1 has a DCE configuration (9-Pin female) for direct attachment to a computer's RS-232 serial port. Power for the LIM-1 is supplied by the computer serial port. The LIM-1 receives the raw serial data from the LPT via a fibre optic cable and transmits them directly to the computer.

#### LIM-3

The LIM-3 receives raw serial data input from the LPT via a fibre optic cable. This data string is analyzed and converted into 0 ... 5 V DC analog output voltages proportional to the ISO codes and also into ModBus ASCII device protocol for interface to a PLC or computer via RS-485 to RS-232 serial port.

Special adapters also allow the integration into an ethernet-computer network. All signal outputs, as well as the input supply voltage (9 ... 36 V DC), are connected to the LIM-3 through a DB-15 connector.

#### LIM-4 and LIM-5

The LIM-4 and LIM-5 receive the raw serial data input from the LPT via a fibre optic cable. Results are displayed on the front panel 3-digit LED display.

The ISO 4406 code number displayed is categorized in four size channels (>4, >6, >14 and >21  $\mu\text{m}_d$ ). The ISO number represents the number of particles counts per ml fluid.

The user also can select internal information about the transducer (temperature C, laser mA, Cal V, Node ID status code). Alarm levels can be programmed for any of the four particle size channels. When set, an alarm indicator will flash if the alarm level is reached. For the LIM-4 the alarm is activated if the measured ISO numbers exceed the set alarm level. For the LIM-5 the alarm is activated if the ISO number falls below the set level.

Alarms on the LIM-4 and LIM-5 may be deactivated by pressing any button. Supply voltage is external and can be from a 9 ... 36 V DC source.

## Dynamic Application Valve - Type DAV

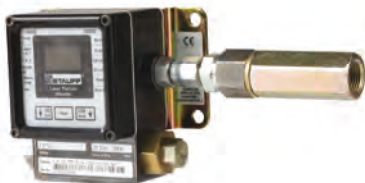

### Product Description

The DAV option is for applications where there is a continuous change of flow or pressure leading up to the LPT. The DAV stabilizes the fluid flow and pressure so that the LPT can read consistent sample volumes.

#### Each DAV includes:

- 1x LPMFC-0.2-3/8BSP
- 1x Thread adaptors for connection of LPT to LPMFC

### Software (optional)

The standard software allows the download and the visualization of the measured particle distribution.

On request, a special software is available that allows the customer to control, monitor and analyse more than one LPM-1 which are connected in a network.

**For custom configuration, please contact STAUFF.**

## Oil Sampling Kit - Type SFSK-1/ -2



### Order Codes

**SFSK-1**

①

#### ① Series and Type

NPT type  
BSP type

**SFSK-1**  
**SFSK-2**

### Components

#### SFSK-1

- 1x Fluid Sample Pump FSP-38
- 1x Hose adaptor SHA-20-5,5mm
- 1 m / 3.28 ft Push on 1/4" hose
- 1x SMK20-1/4NPT-VD-C6F
- 1x SMK20-7/16UNF-VE-C6F
- Sample bottles

#### SFSK-2

- 1x Fluid Sample Pump FSP-38
- 1x Hose adaptor SHA-20-5,5mm
- 1 m / 3.28 ft Push on 1/4" hose
- 1x SMK20-G1/4-PC-C6F
- 1x SMK20-M10x1-PA-C6F
- Sample bottles

### Product Description

Fluid analysis is a crucial component of any oil management program. Early detection of potential problems can prevent costly repairs and downtime. STAUFF SFSK oil analysis kits provide the tools to take a sample from a STAUFF test coupling or directly from a reservoir or sump.

For this the supplied hose is directly connected to the test coupling with an adapter and the fluid is filled into the supplied vials.

But there is also the possibility to draw up the sample directly from a tank with the hand pump and fill it into the vial.

This sample set is available in two versions with BSP and NPT test couplings.

### Scope of Delivery

- Contains vacuum pump for drawing samples of oil equipment
- 1 m / 3.28 ft hose for insertion into tank
- Two sample bottles
- STAUFF test points and adaptor allows oil sample to be taken from STAUFF Test 20 test points

## Sensors and Switches



The continuous monitoring of critical hydraulic systems has become normal in today's market. The automatic and timely detection of problems in hydraulic systems can predict component failure and thereby eliminate catastrophic system failures. The advent of automated processes systems have made continuous monitoring and control components indispensable.

With the STAUFF line of industrial and mobile sensor, it is possible to continuously monitor and control your machine and process.

The wide range of STAUFF transmitters and switches available, enables proper fit to any application need.

The STAUFF line of simple pressure and temperature switches are factory set, or adjustable via a screw. The switches can be ordered normally open, normally closed, or SPDT.

The STAUFF transmitters are available in many pressure and temperature ranges. Output signals are available in 4 ... 20 mA and 0 ... 10 V. Other signals are available on many items. The process connections are available in NPT, SAE, BSP for international use.

All sensors can be ordered with flying leads, DIN connectors or other options to fit the environment.

## Level-Temperature Switch - Type SLTS

## Wiring Scheme

two level contacts

one temperature contact

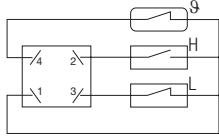

one level contact

one temperature contact

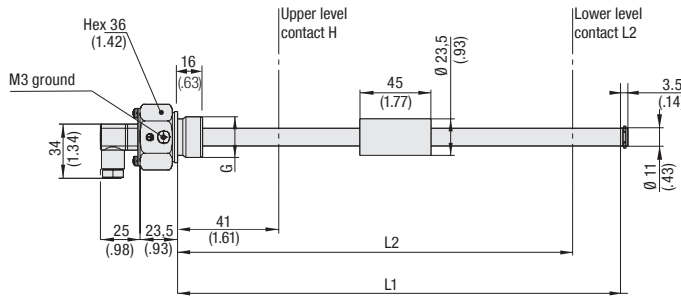
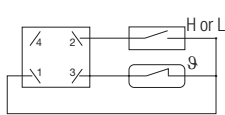

## Order Codes

**SLTS 12 - 0 - H41 - L251 - B12 - G048 - M12**

## ① Series and Type

 Level-Temperature Switch **SLTS**

## ② Stem Length

 L1: 305 mm / 12 in L2: 251 mm / 9.88 in **12**  
 L1: 457 mm / 18 in L2: 403 mm / 15.87 in **18**

## ③ Switching Temperature

 Without temperature switch **0**  
 +60 °C / +140 °F **140**  
 +70 °C / +158 °F **158**

## ④ H (Upper Level Contact)

 Without upper level contact **0**  
 41 mm / 1.61 in **H41**

## ⑤ L2 (Lower Level Contact)

 Without lower level contact **0**  
 251 mm / 9.88 in (SLTS 12 only) **L251**  
 403 mm / 15.87 in (SLTS 18 only) **L403**

## ⑥ Process Connection

 G3/4 (standard option) **B12**  
 1 NPT **N16**

Note: Others on request

## ⑦ Voltage (Volt AC/DC)

 48 Volt max. (standard option) **G048**  
 115 Volt max. (for thread N16 only) **G115**

## ⑧ Electrical Connection

 similar DIN VDE 0627 / IEC 61984 **CB**  
 M12 pin terminal **M12**

## Product Description

The STAUFF Level-Temperature Switches (SLTS Series) are unique in their design and modularity. One of the greatest advantages is the ability of the end-user to adjust the switching level. The internal support wire carrying the level and temperature switches makes it a simple and quick job to change the level switch position.

**Level contact positions (L2, H) are set as given in the order code. They can be adjusted individually later on. Please consider a minimum distance of 40 mm / 1.57 in between the switching points.**

## Features

- Suitable for Mineral Oil and HFC fluids, other fluids on request
- Either 1 or 2 level contacts available
- 1 integrated temperature sensor (optional)
- Standard electrical function:
  - Level contacts: Normally closed, opens with falling level
  - Temperature contacts: Normally closed, opens with rising temperature

**STAUFF Level-Temperature Switches SLTS are available with other electrical functions on request.**

## Options

- 1 NPT and others available on request
- max. 115 Volt switching (for thread N16 only)

## Technical Data

## Materials

- Stem: Brass
- Float/Sealing: NBR (Buna-N®)

- Max. operating temp.: +80 °C / +176 °F

## Electrical Data and Output

- Max. current level contact: 0.5 A
- Max. current temp. contact: 2.0 A
- Contact load level contact: 10 VA
- Max. operating voltage: (See ordering code)

- Specific gravity of fluid:  $\geq 0,8 \text{ kg/dm}^3$
- Hysteresis: +12 °C / +53.6 °F

## Protection Rating

- IP 65 protection rating: Dust tight and protected against water jets

## Contact Life Time

Due to their design Reed contacts have a very high life expectancy. However, it is worthwhile to note the following information.

## Contact Protection

To reduce the high reverse voltage produced when a reed switch opens, the following contact protection can be applied.

- DC voltage: a diode parallel to the load, see figure A
- AC voltage: a RC-network parallel to the load, see figure B and table below

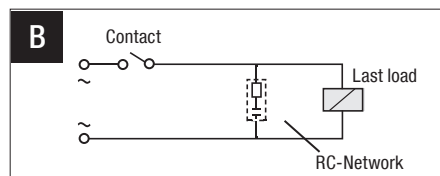
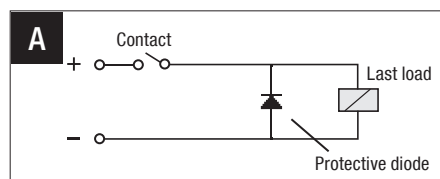

Open contact voltage V	10 VA		25 VA		50 VA		75 VA		100 VA	
	R (Ω)	C (μF)	R (Ω)	C (μF)	R (Ω)	C (μF)	R (Ω)	C (μF)	R (Ω)	C (μF)
24	22	0,022	1	0,1	1	0,47	1	1	1	1
48	120	0,0047	22	0,022	1	0,1	1	0,47	1	0,47
110	470	0,001	120	0,0047	22	22	22	0,047	22	0,1

## Level-Temperature Switch Aluminium ▪ Type SLTSA

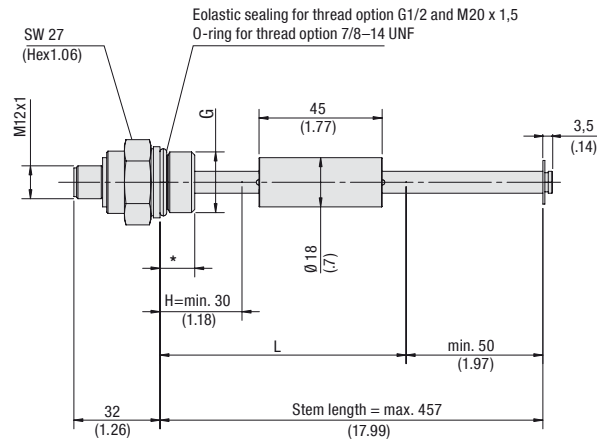

\* 14 (.55) for thread option G1/2 and M20 x 1,5  
13 (.51) for thread option 7/8-14 UNF

### Wiring Scheme

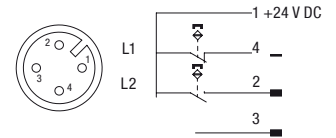

### Product Description

Efficient and inexpensive indication of level and temperature.

### Features

- Threads: G1/2, 7/8-14 UNF, M20 x 1,5
- Stem length available from 140 ... 457 mm / 5.5 ... 18.00 in
- Electrical connection M12 / 4-Pin terminal

### Technical Data

#### Materials

- Connector: Anodized Aluminium
- Stem: Brass
- Float: Polyurethane
- Sealing: NBR (Buna-N®)

#### Electrical Connection

- Connector type: M12 x 1 / 4-Pin

- Max. operating pressure: 1 bar / 14.5 PSI

#### Permissible Temperature

- Operating: -20°C ... +80°C / -4°F ... +176°F

- Specific gravity of fluid:  $\geq 0,8 \text{ kg/dm}^3$

#### Electrical Data and Output

- Level contact type: K40
- Max. operating voltage: 36 V
- Max. current: 0.5 A
- Contact load: 5 VA

#### Protection Rating

- IP 67 protection rating: Dust tight and protected against powerful water jets; even immersion (up to 1 m / 3.28 ft) in water is possible under defined conditions of pressure and time

### Order Codes

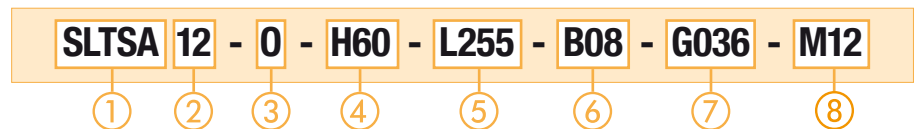

#### ① Series and Type

Level-Temperature Switch Aluminium **SLTSA**

#### ② Stem Lengths

140 mm / 5.51 in	<b>55</b>
170 mm / 6.69 in	<b>67</b>
215 mm / 8.46 in	<b>85</b>
280 mm / 11.02 in	<b>11</b>
305 mm / 12.01 in	<b>12</b>
370 mm / 14.57 in	<b>146</b>
457 mm / 18.00 in	<b>18</b>

#### ③ Switching Temperature

Without temperature switch **0**

#### ④ H (Upper Level Contact)

30 mm / 1.18 in (only for stem length code 55)	<b>H30</b>
50 mm / 1.97 in (only for stem length code 67)	<b>H50</b>
60 mm / 2.36 in (only for stem length codes 55, 12, 18)	<b>H60</b>
85 mm / 3.35 in (only for stem length code 85)	<b>H85</b>
90 mm / 3.54 in (only for stem length codes 67, 12, 18)	<b>H90</b>
135 mm / 5.31 in (only for stem length code 85)	<b>H135</b>
200 mm / 7.87 in (only for stem length code 11)	<b>H200</b>
290 mm / 11.42 in (only for stem length code 146)	<b>H290</b>

#### ⑤ L (Lower Level Contact)

90 mm / 3.54 in (only for stem length code 55)	<b>L90</b>
120 mm / 4.72 in (only for stem length code 67)	<b>L120</b>
165 mm / 6.50 in (only for stem length code 85)	<b>L215</b>
230 mm / 9.06 in (only for stem length code 11)	<b>L230</b>
255 mm / 10.04 in (only for stem length code 12)	<b>L255</b>
320 mm / 12.60 in (only for stem length code 146)	<b>L320</b>
407 mm / 16.02 in (only for stem length code 18)	<b>L407</b>

#### ⑥ Process Connection

G1/2 (standard option)	<b>B08</b>
7/8-14 UNF	<b>U10</b>
M20 x 1,5	<b>M20</b>

#### ⑦ Voltage

36 Volt max.	<b>G036</b>
--------------	-------------

#### ⑧ Electrical Connection

M12 / 4-Pin terminal	<b>M12</b>
----------------------	------------

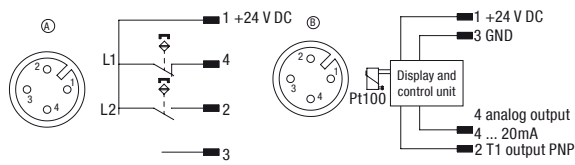
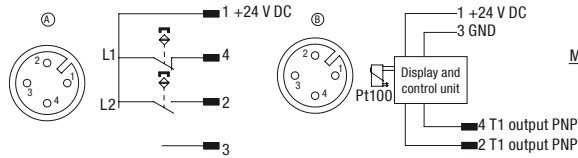

**Wiring Scheme**
**for SLTSD...-1-...**
**1 temperature PNP switch output + 1 Analog Output 4 ... 20mA**

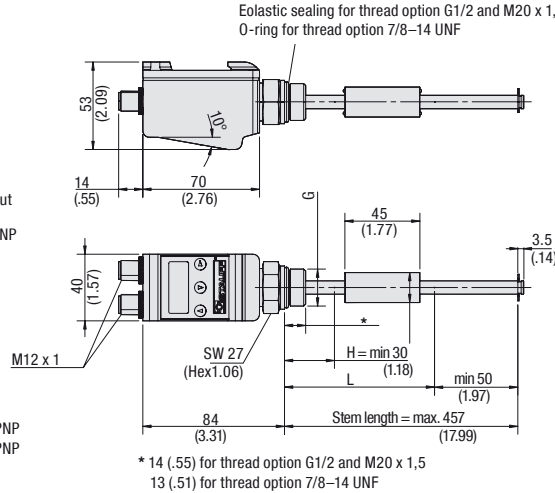
**for SLTSD...-2-...**
**2 temperature PNP switch outputs**

**Level-Temperature Switch Display - Type SLTSD**

 Elastic sealing for thread option G1/2 and M20 x 1,5  
 O-ring for thread option 7/8-14 UNF

**Order Codes**

**1 Series and Type**

 Level-Temperature Switch Display **SLTSD**
**2 Stem Length**

140 mm / 5.51 in	<b>55</b>
170 mm / 6.69 in	<b>67</b>
215 mm / 8.46 in	<b>85</b>
280 mm / 11.02 in	<b>11</b>
305 mm / 12.01 in	<b>12</b>
370 mm / 14.57 in	<b>146</b>
457 mm / 18.00 in	<b>18</b>

**3 Temperature Output Options**

2x PNP switch outputs	<b>1</b>
1x PNP switch outputs + 1x analog 4 ... 20mA	<b>2</b>

**4 H (Upper Level Contact)**

30 mm / 1.18 in (only for stem length code 55)	<b>H30</b>
50 mm / 1.97 in (only for stem length code 67)	<b>H50</b>
60 mm / 2.36 in (only for stem length codes 55, 12, 18)	<b>H60</b>
85 mm / 3.35 in (only for stem length code 85)	<b>H85</b>
90 mm / 3.54 in (only for stem length codes 67, 12, 18)	<b>H90</b>
135 mm / 5.31 in (only for stem length code 85)	<b>H135</b>
200 mm / 7.87 in (only for stem length code 11)	<b>H200</b>
290 mm / 11.42 in (only for stem length code 370)	<b>H290</b>

**5 L (Lower Level Contact)**

90 mm / 3.54 in (only for stem length code 55)	<b>L90</b>
120 mm / 4.72 in (only for stem length code 67)	<b>L120</b>
165 mm / 6.50 in (only for stem length code 85)	<b>L215</b>
230 mm / 9.06 in (only for stem length code 11)	<b>L230</b>
255 mm / 10.04 in (only for stem length code 12)	<b>L255</b>
320 mm / 12.60 in (only for stem length code 146)	<b>L320</b>
407 mm / 16.02 in (only for stem length code 18)	<b>L407</b>

**6 Process Connection**

G1/2 (standard option)	<b>B08</b>
7/8-14 UNF	<b>U10</b>
M20 x 1,5	<b>M20</b>

**7 Voltage**

36 Volt max.	<b>G036</b>
--------------	-------------

**8 Electrical Connection**

M12 / 4-Pin terminal	<b>M12</b>
----------------------	------------

**Product Description**

Combination of a temperature controller with level indication in a small inexpensive package.

**Features**

- Threads: G1/2, 7/8-14 UNF, M20 x 1,5
- Stem length available from 140 ... 457 mm / 5.5 ... 18.00 in
- Electrical connection M12 / 4-Pin terminal

**Technical Data**
**Materials**

- Housing: Polyamide
- Connector: Anodized Aluminium
- Stem: Brass
- Float: Polyurethane

**Electrical Connection**

- Connector type: M12 x 1 / 4-Pin

- Max. operating pressure: 1 bar / 14.5 PSI

**Permissible Temperature**

- Operating: -20 °C ... +80 °C / -4 °F ... +176 °F
- Specific gravity of fluid: ≥ 0,8 kg/dm<sup>3</sup>

**Level Contacts (Connector A)**

- Level contact type: K40
- Max. operating voltage: 36 V
- Max. current: 0.5 A
- Contact load: 5 VA

**Temperature Outputs (Connector B)**

- Output option 1: Two PNP programmable switching outputs
- Output option 2: One PNP switching output and one 4 ... 20 mA analog output
- Max. current: 0.5 A
- Load resistance: 500 Ω

**Display**

- Display temp. range: -20 °C ... +120 °C / -4 °F ... +248 °F
- Alarm indication range: 0 °C ... +100 °C / +32 °F ... +212 °F
- LED display: 4 digit, 7 segment
- Resolution: 0,5 °C / 1 °F
- Current consumption at power up: 100 mA for 100ms
- Current consumption at operating: 50 mA
- Supply voltage: 10 ... 32 V DC
- Ambient temperature: -20 °C ... +70 °C / -4 °F ... +158 °F
- Accuracy: ±1 % FS\*
- Sensor type: Temperature: PT100

**Protection Rating**

- IP 65 protection rating: Dust tight and protected against water jets (IP 67 with accordant connection plug)

\*FS = Full Scale

Dimensional drawings: All dimensions in mm (in).

## Pressure Switch ▪ Type SPW-...-NC/NO

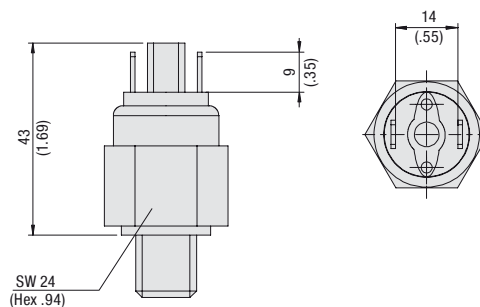

### Wiring Scheme

#### Wiring diagram normally open



#### Wiring diagram normally closed



### Product Description

The SPW Mechanical Pressure Switch is available in a variety of pressure ranges. This durable unit has an adjustable set point that is easily changed by using the adjustment screw which is located under the protective cap.

### Features

- Normally open, normally closed
- Pressure ranges available up to 206 bar / 3000 PSI
- G1/4 and 1/4 NPT process connection
- NBR (Buna-N®) sealings
- Steel, zinc plated
- Spade terminal connection

### Options

- G1/8, 1/8 NPT and 7/16–20 UNF process connections
- FPM (Viton®) and EPDM sealings on request
- Flying leads with shrink tubing, flying leads, rubber boot, Deutsch connector, weather pack connector female/male and IP option on request
- 316 Stainless Steel

### Technical Data

#### Materials

- Body: Steel, zinc plated or 316 Stainless Steel
- Connector: Polyamide

#### Electrical Data and Output

- Switching function: Normally open (NO), normally closed (NC)
- Cycle rate: 30 CPM
- Mechanical life: 2000000 operations
- Max. electrical rating: 100 VA

#### Permissible Temperatures

- NBR (Buna-N®): -9 °C ... +110 °C / +15 °F ... +230 °F
- FPM (Viton®): -18 °C ... +110 °C / 0 °F ... +230 °F
- EPDM: -40 °C ... +110 °C / -40 °F ... +230 °F

#### Process Connection

- G1/8, G1/4, 1/8 NPT, 1/4 NPT and 7/16–20UNF

#### Electrical Connection

- Spade terminals

#### Protection Rating

- IP 00 protection rating

### Order Codes



#### ① Series and Type

Mechanical Pressure Switch **SPW**

#### ② Version

1 ... 4 bar / 14.5 ... 60 PSI	<b>B0004</b>
3 ... 10 bar / 40 ... 150 PSI	<b>B0010</b>
6 ... 18 bar / 75 ... 275 PSI	<b>B0018</b>
11 ... 34 bar / 150 ... 500 PSI (standard option)	<b>B0034</b>
19 ... 55 bar / 275 ... 800 PSI	<b>B0055</b>
28 ... 75 bar / 400 ... 1100 PSI (standard option)	<b>B0075</b>
69 ... 206 bar / 1000 ... 3000 PSI (standard option)	<b>B0206</b>

#### ③ Process Connection

G1/8	<b>B02</b>
G1/4 (standard option)	<b>B04</b>
1/8 NPT	<b>N02</b>
1/4 NPT (standard option)	<b>N04</b>
7/16–20 UNF	<b>U04</b>

#### ④ Switching Outputs

Normally open (standard option)	<b>NO</b>
Normally closed	<b>NC</b>

#### ⑤ Electrical Connection

Spade terminals (standard option)	<b>SP</b>
Flying leads	<b>F</b>
Flying leads with shrink tubing	<b>FL</b>
Deutsch DT04-3P / 3-Pin	<b>D</b>
Rubber boot	<b>RB</b>
Weather pack connector female	<b>WF</b>
Weather pack connector male	<b>WM</b>
IP Option (IP 66)	<b>IP</b>

Note: IP Option requires a fixed set point indicate at the end of part number.

#### ⑥ Body Material

Steel, zinc plated (standard option)	<b>(none)</b>
316 Stainless Steel	<b>W5</b>

### Pressure Ranges

Version	Pressure Range (bar/psi)	Maximum Pressure (bar/psi)	Burst Pressure (bar/psi)	Repeatability	Average Deadband
<b>B0004</b>	1 ... 4	410	600	±0,10 bar + 3 % of setting	0,21 bar + 5 % of setting
	14.5 ... 60	6000	9000	±1.5 PSI + 3 % of setting	3 PSI + 5 % of setting
<b>B0010</b>	3 ... 10	410	600	±0,17 bar + 3 % of setting	0,35 bar + 6 % of setting
	40 ... 150	6000	9000	±2.5 PSI + 3 % of setting	5 PSI + 6 % of setting
<b>B0018</b>	6 ... 18	410	600	±0,26 bar + 3 % of setting	0,48 bar + 8 % of setting
	75 ... 275	6000	9000	±3.75 PSI + 3 % of setting	7 PSI + 8 % of setting
<b>B0034*</b>	11 ... 34	410	600	±0,34 bar + 3 % of setting	0,69 bar + 10 % of setting
	150 ... 500	6000	9000	±5 PSI + 3 % of setting	10 PSI + 10 % of setting
<b>B0055</b>	19 ... 55	410	600	±0,55 bar + 3 % of setting	10,3 bar + 11 % of setting
	275 ... 800	6000	9000	±8 PSI + 3 % of setting	15 PSI + 11 % of setting
<b>B0075*</b>	28 ... 75	410	600	±0,90 bar + 3 % of setting	2,07 bar + 12 % of setting
	400 ... 1100	6000	9000	±13 PSI + 3 % of setting	30 PSI + 12 % of setting
<b>B0206*</b>	69 ... 206	410	600	±2,41 bar + 3 % of setting	4,83 bar + 14 % of setting
	1000 ... 3000	6000	9000	±35 PSI + 3 % of setting	70 PSI + 14 % of setting

\* Standard option

Dimensional drawings: All dimensions in mm (in).

## Pressure Switch ▪ Type SPW-SD

## Wiring Scheme

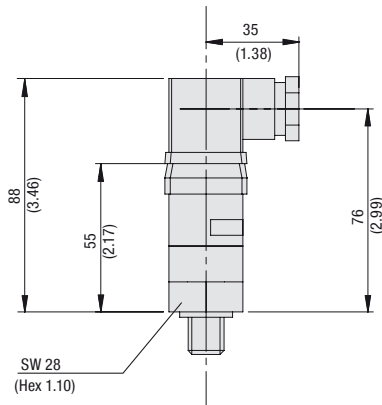
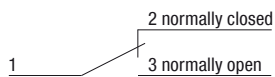

## Order Codes

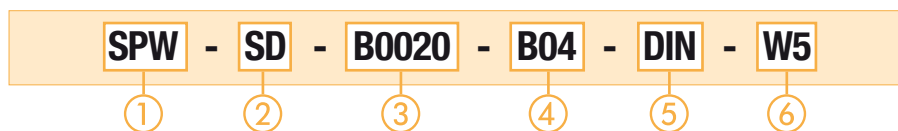

## ① Series and Type

 Mechanical Pressure Switch **SPW**

## ② Switching Function

 SPDT **SD**

## ③ Version

0,7 ... 2 bar / 10 ... 30 PSI	<b>B0002</b>
1,7 ... 5,2 bar / 25 ... 75 PSI	<b>B0005</b>
4,5 ... 20,7 bar / 65 ... 300 PSI (standard option)	<b>B0020</b>
17,2 ... 69 bar / 250 ... 1000 PSI (standard option)	<b>B0069</b>
69 ... 206 bar / 1000 ... 3000 PSI (standard option)	<b>B0206</b>
173 ... 344 bar / 2500 ... 5000 PSI	<b>B0344</b>

## ④ Process Connection

G1/8	<b>B02</b>
G1/4 (standard option)	<b>B04</b>
1/8 NPT	<b>N02</b>
1/4 NPT (standard option)	<b>N04</b>
7/16–20 UNF	<b>U04</b>

## ⑤ Electrical Connection

Flying leads	<b>F</b>
Flying leads with shrink tubing	<b>FL</b>
DIN EN 175301-803A (DIN 43650-A) (standard option)	<b>DIN</b>
Deutsch DT04-3P / 3-Pin	<b>D</b>
Weather pack connector female	<b>WF</b>
Weather pack connector male	<b>WM</b>
IP Option (IP 66)	<b>IP</b>

## ⑥ Body Material

Steel, zinc plated (standard option)	<b>(none)</b>
316 Stainless Steel	<b>W5</b>

## Pressure Ranges

Version	Pressure Range (bar/psi)	Maximum Pressure (bar/psi)	Burst Pressure (bar/psi)	Repeatability	Average Deadband
B0002	0,7 ... 2	410	600	±0,10 bar + 2 % of setting	0,24 bar + 11 % of setting
	10 ... 30	6000	9000	±1.5 PSI + 2 % of setting	3.5 PSI + 11 % of setting
B0005	1,7 ... 5,2	410	600	±0,17 bar + 2 % of setting	0,24 bar + 11 % of setting
	25 ... 75	6000	9000	±2.5 PSI + 2 % of setting	3.5 PSI + 11 % of setting
B0020*	4,5 ... 20,7	410	600	±0,34 bar + 2 % of setting	1,38 bar + 11 % of setting
	65 ... 300	6000	9000	±5 PSI + 2 % of setting	20 PSI + 11 % of setting
B0069*	17,2 ... 69	410	600	±1,03 bar + 2 % of setting	3,10 bar + 12 % of setting
	250 ... 1000	6000	9000	±15 PSI + 2 % of setting	45 PSI + 12 % of setting
B0206*	69 ... 206	410	600	±2,07 bar + 2 % of setting	4,83 bar + 12 % of setting
	1000... 3000	6000	9000	±30 PSI + 2 % of setting	70 PSI + 12 % of setting
B0344	173 ... 344	410	600	±3,45 bar + 2 % of setting	9,65 bar + 13 % of setting
	2500 ... 5000	6000	9000	±50 PSI + 2 % of setting	140 PSI + 13 % of setting

\* Standard option

Dimensional drawings: All dimensions in mm (in).

## Product Description

The SPW-SD Mechanical SPDT Pressure Switch is available in a variety of pressure ranges. This durable unit has an adjustable set point that is easily changed by using the adjustment screw which is located under the protective cap.

## Features

- SPDT switching function
- Pressure ranges available up to 344 bar / 5000 PSI
- G1/4 and 1/4 NPT process connection
- NBR (Buna-N®) sealings
- Steel, zinc plated
- Spade terminal connection

## Options

- G1/8, 1/8 NPT and 7/16–20 UNF process connections
- FPM (Viton®) and EPDM sealings on request
- Flying leads with shrink tubing, flying leads, Deutsch connector, weather pack connector female/male and IP option on request
- 316 Stainless Steel

## Technical Data

## Materials

- Body: Steel, zinc plated or 316 Stainless Steel
- Connector: Polyamide

## Electrical Data and Output

- Switching function: SPDT
- Cycle rate: 20 CPM
- Mechanical life: 2000000 operations
- Max. electrical rating: 5 A at 125/250 VAC, 5 A resistive / 3 A inductive at 28 VDC

## Permissible Temperatures

- NBR (Buna-N®): -9°C ... +85°C / +15°F ... +185°F
- FPM (Viton®): -18°C ... +85°C / 0°F ... +185°F
- EPDM: -23°C ... +85°C / -10°F ... +185°F

## Process Connections

- G1/8, G1/4, 1/8 NPT, 1/4 NPT and 7/16–20UNF

## Electrical Connection

- DIN EN 175301-803 form A (DIN 43650-A)

## Protection Rating

- IP 65 protection rating: Dust tight and protected against water jets

## Pressure Transmitters ▪ Type SPT



### Product Description

The SPT Pressure Transmitter is designed for many industrial and OEM pressure measurement applications. The SPT pressure transmitters convert applied pressure from 1 bar up to 600 bar / 14.5 PSI up to 8702 PSI into the corresponding output signals. The SPT Series provides resistance to vibration, shock, wide temperature variations and many other extreme environmental conditions that are typical of industrial and OEM applications.

### Features

- Stainless Steel housing construction
- L-plug DIN EN 175301-803A (DIN 43650-A) electrical connection
- Pressure ranges up to 600 bar / 8702 PSI
- G1/4 or 1/4 NPT process connection
- Output signal 4 ... 20 mA
- Non-linearity  $\leq \pm 0.5\%$  BFSL
- Environmental protection of IP 65  
(IP 65 protection rating: Dust tight and protected against water jets)
- Protection against incorrect polarity, short circuits and over-voltage
- Temperature compensated
- Long term stability

### Options

- Mini L-plug DIN EN 175301-803C, M12 x 1 and flying lead electrical connections
- 1/2 NPT and 7/16–20 UNF process connections
- Output signals 0 ... 5 V, 0 ... 10 V, 1 ... 5 V and 0,5 ... 4,5 V ratiometric on request
- Non-linearity  $\leq \pm 0.25\%$  BFSL
- Environmental protection of IP 67  
(IP 67 protection rating: Dust tight and protected against powerful water jets; even immersion (up to 1 m / 3.28 ft) in water is possible under defined conditions of pressure and time)
- Extended temperature option on request  
-30 °C ... +100 °C / -22 °F ... +212 °F

### Order Codes

①	②	③	④	⑤	⑥
<b>SPT</b>	<b>- B0400</b>	<b>- B04</b>	<b>- 420A</b>	<b>- DIN</b>	<b>- W5</b>
<b>① Series and Type</b>					
Pressure Transmitter		<b>SPT</b>			
<b>② Version</b>					
0 ... 1 bar / 0 ... 14.5 PSI		<b>B0001</b>			
0 ... 1,6 bar / 0 ... 23 PSI		<b>B001.6</b>			
0 ... 2,5 bar / 0 ... 36 PSI		<b>B002.5</b>			
0 ... 4 bar / 0 ... 58 PSI		<b>B0004</b>			
0 ... 6 bar / 0 ... 87 PSI		<b>B0006</b>			
0 ... 10 bar / 0 ... 145 PSI		<b>B0010</b>			
0 ... 16 bar / 0 ... 232 PSI (standard option)		<b>B0016</b>			
0 ... 25 bar / 0 ... 362 PSI		<b>B0025</b>			
0 ... 40 bar / 0 ... 580 PSI (standard option)		<b>B0040</b>			
0 ... 60 bar / 0 ... 870 PSI		<b>B0060</b>			
0 ... 100 bar / 0 ... 1450 PSI (standard option)		<b>B0100</b>			
0 ... 160 bar / 0 ... 2320 PSI (standard option)		<b>B0160</b>			
0 ... 250 bar / 0 ... 3625 PSI		<b>B0250</b>			
0 ... 400 bar / 0 ... 5801 PSI (standard option)		<b>B0400</b>			
0 ... 500 bar / 0 ... 7251 PSI		<b>B0500</b>			
0 ... 600 bar / 0 ... 8702 PSI (standard option)		<b>B0600</b>			
			<b>③ Process Connection</b>		
			G1/4 (standard option)	<b>B04</b>	
			1/4 NPT (standard option)	<b>N04</b>	
			1/2 NPT	<b>N08</b>	
			7/16–20 UNF	<b>U04</b>	
			<b>④ Signal Output</b>		
			4 ... 20 mA, 2-wire (standard option)	<b>420A</b>	
			0 ... 10 V, 3-wire	<b>010V</b>	
			0 ... 5 V, 3-wire	<b>05V</b>	
			1 ... 5 V, 3-wire	<b>15V</b>	
			0,5 ... 4,5 V, ratiometric	<b>0545V</b>	
			<b>⑤ Electrical Connection</b>		
			DIN EN 175301-803A (DIN 43650-A) (standard option)	<b>DIN</b>	
			DIN EN 175301-803C	<b>MD</b>	
			M12 x 1 / 4-Pin	<b>M12</b>	
			Flying leads with shrink tubing	<b>FL</b>	
			<b>⑥ Body Material</b>		
			Steel, zinc plated (standard option)	<b>(none)</b>	
			316 Stainless Steel	<b>W5</b>	

## Pressure Transmitters ▪ Type SPT



## Technical Data

**Materials**

- Body: 316 L Stainless Steel

**Internal Transmission Fluid**

- Silicone Oil (only pressure ranges up to 0 ... 10 bar / 0 ... 100 PSIG and 0 ... 25 bar / 0 ... 300 PSI absolute)

**Fatigue Life**

- 10 million load cycles maximum

**Signal Output and Maximum Load**

- Signal 4 ... 20 mA, 2-wire:  
Power supply 8 ... 30 V DC  
Ra <= ( UB-10 V) / 0,02A

- Signal 0 ... 10 V, 3-wire:  
Power supply 14 ... 30 V DC  
Ra > 10kΩ

- Signal 0 ... 5 V, 3-wire:  
Power supply 8 ... 30 V DC  
Ra > 5kΩ

- Signal 1 ... 5 V, 3-wire:  
Power supply 8 ... 30 V DC  
Ra > 5kΩ

- Signal 0,5 ... 4,5 V, ratiometric:  
Power supply 8 ... 30 V DC  
Ra > 4,5kΩ

**Isolation Voltage**

- 500 V DC

**Response Time**

- < 4 ms

**Current Consumption**

- Signal current:  
(max. 25 mA) for current output,  
(max. 8 mA) for voltage output

**Non-linearity**

- ≤ ± 0,5 % (BFSL) or optional ≤ ± 0,25 % (BFSL)

**Accuracy**

- ≤ ± 1,0 % FS\* (with non-linearity 0,5 %) \*
- ≤ ± 0,5 % FS\* (with non-linearity 0,25 %) \*
- ≤ ± 0,6 % FS\* (with non-linearity 0,25 % and signal output 0 ... 5 V) \*
- \* (Includes non-linearity, hysteresis, zero point and full scale error)

**Zero Offset**

- ≤ 0,15 typ. % FS\*; ≤ 0,4 max. % of span (non-linearity 0,25 %)
- ≤ 0,5 typ. % FS\*; ≤ 0,8 max. % of span (non-linearity 0,25 %)

**Hysteresis**

- ≤ 0,16 % FS\*

**Non-repeatability**

- ≤ 0,1 % FS\*

**Long Term Drift**

- ≤ 0,1 % FS\*

**Signal Noise**

- ≤ 0,3 % FS\*

**Permissible Temperatures (Standard)**

- Media: 0 °C ... +80 °C / +32 °F ... +176 °F
- Ambient: 0 °C ... +80 °C / +32 °F ... +176 °F
- Storage: -20 °C ... +80 °C / -4 °F ... +176 °F
- Operating temp. range: 0 °C ... +80 °C / +32 °F ... +176 °F

**Permissible Temperatures (Extended Temperature Option)**

- Media: -30 °C ... +100 °C / -22 °F ... +212 °F
- Ambient: -30 °C ... +100 °C / -22 °F ... +212 °F
- Storage: -30 °C ... +100 °C / -22 °F ... +212 °F

**Electrical Connection**

- DIN EN 175301-803A (DIN 43650-A), DIN EN 175301-803C  
M12 x 1 / 4-Pin, flying leads

**Process Connection**

- G1/4, 1/4 NPT, 1/2 NPT, 7/16-20 UNF

**Temperature Error within Compensated Temperature Range**

- ≤ 1,0 typ. % FS\* ≤ 2,5 max. % FS\*

**CE Conformity**
**Pressure Equipment Directive**

- 97/23/EC

**EMC Directive**

- 89/336/EWG emission (class B) and immunity according to EN 61 326

**Shock Resistance**

- 500g according to IEC 60068-2-27 (mechanical shock)

**Vibration Resistance**

- 10g according to IEC 60068-2-6 (vibration under resonance)

**Wiring Protection**

- Overvoltage protection: 32 V DC; 36 V DC with 4 ... 20 mA
- Short circuit protection: Sig+ to UB-
- Reverse polarity protection: UB+ to UB-

**Test Reference Conditions**

- Relative humidity: 45 ... 75 %
- Temperature: +15 °C ... +25 °C / +59 °F ... +77 °F
- Atmospheric pressure: 86 ... 106 kPa / 25,4 ... 31,3 inh

**RoHS-conformity**

- Yes

**Weight**

- Approximately 80g / 2.8 oz

**Protection Rating**

- DIN EN 175301-803A: IP 65 protection rating: Dust tight and protected against water jets (DIN 43650-A)
- DIN EN 175301-803C: IP 65 protection rating: Dust tight and protected against water jets  
IP 67 protection rating: Dust tight and protected against powerful water jets; even immersion (up to 1 m / 3.28 ft) in water is possible under defined conditions of pressure and time
- M 12 x 1:  
IP 67 protection rating: Dust tight and protected against powerful water jets; even immersion (up to 1 m / 3.28 ft) in water is possible under defined conditions of pressure and time
- Flying leads:  
IP 67 protection rating: Dust tight and protected against powerful water jets; even immersion (up to 1 m / 3.28 ft) in water is possible under defined conditions of pressure and time

\* FS = Full Scale

## Pressure Transmitters - Type SPT

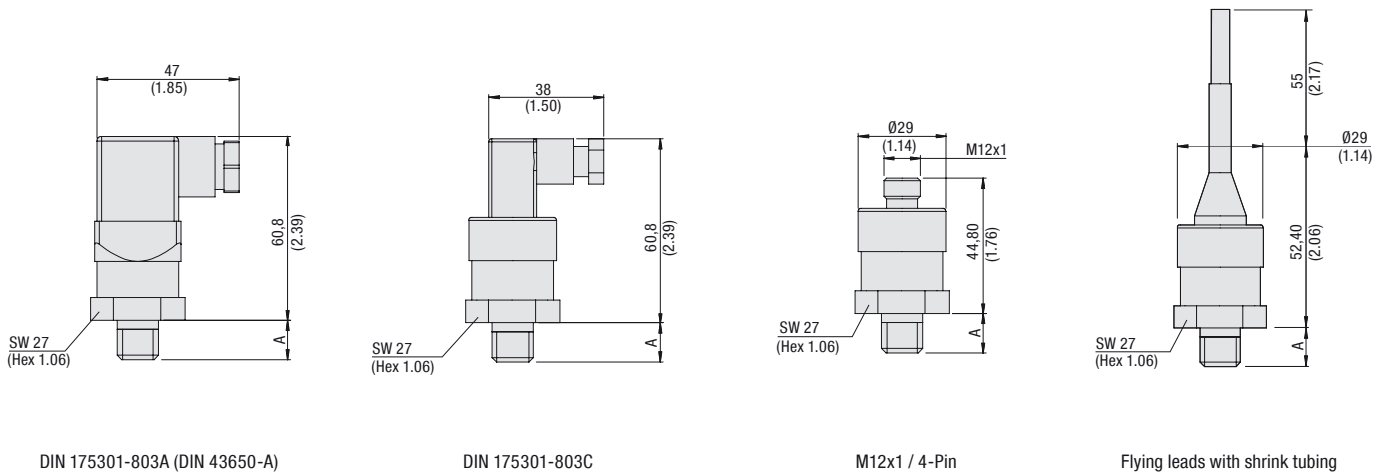

### Dimensions

Version	A (mm/in)	Process Connection
B04	14,0	G1/4
	.55	
N04	13,0	1/4 NPT
	.51	
N08	19,0	1/2 NPT
	.75	
U04	9,1	7/16-20 UNF
	.36	

### Pressure Ranges

Version	Pressure Range (bar/psi)	Maximum Pressure ** (bar/psi)	Burst Pressure *** (bar/psi)
B0001	0 ... 1	2	5
	0 ... 14.5	29	72
B001.6	0 ... 1,6	3,2	10
	0 ... 23	46	145
B002.5	0 ... 2,5	5	10
	0 ... 36	72	145
B0004	0 ... 4	8	17
	0 ... 58	116	246
B0006	0 ... 6	12	34
	0 ... 87	174	493
B0010	0 ... 10	20	34
	0 ... 145	290	493
B0016*	0 ... 16	32	100
	0 ... 232	464	1450
B0025	0 ... 25	50	100
	0 ... 362	725	1450
B0040*	0 ... 40	80	400
	0 ... 580	1160	5801
B0060	0 ... 60	120	550
	0 ... 870	1740	7977
B0100*	0 ... 100	200	800
	0 ... 1450	2900	11603
B0160*	0 ... 160	320	1000
	0 ... 2320	4641	14503
B0250	0 ... 250	500	1200
	0 ... 3625	7251	17404
B0400*	0 ... 400	800	1700
	0 ... 5801	11603	24656
B0500	0 ... 500	1200	2400
	0 ... 7251	17404	34809
B0600*	0 ... 600	1200	2400
	0 ... 8702	17404	34809

#### Note:

- Absolut pressure: 0 ... 1 bar up to 0 ... 25 bar  
0 ... 14.5 PSI up to 0 ... 362 PSI
- +/- Measuring range:  
-1 ... 0 bar up to -1 ... 24 bar  
-14.5 ... 0 PSI up to -14.5 ... 348 PSI

#### \* Standard option

- \*\* Maximum pressure, causing no perminate changes in specifications but may lead to zero point and span shifts
- \*\*\* Burst pressure, leading to perminate changes in specifications or destruction of the transmitter

## Pressure Transmitters - Type SPT

## Electrical Connections

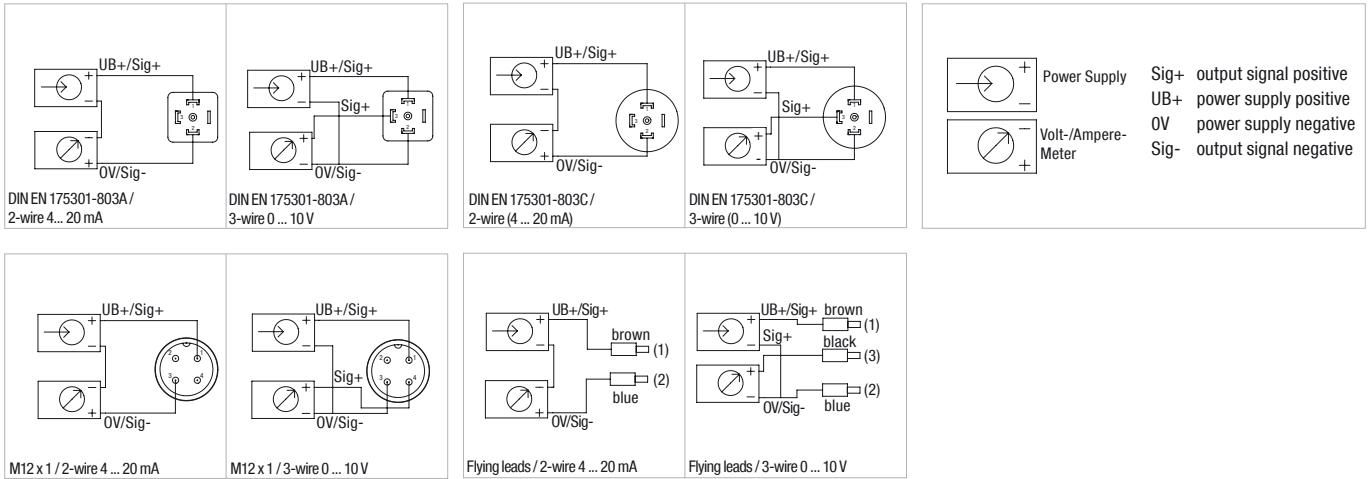

## Pressure Transmitters ▪ Type PT



### Product Description

The PT Pressure Transmitters features a durable fibre-glass reinforced PBT case, an internal metal sleeve for excellent EMI protection and an all welded thin film measuring cell for exceptional long term stability. This product is available with a flying lead option which is rated to IP69K for resistance to high pressure steam wash down. Produced on a high volume fully automated assembly line, the PT Pressure Transmitter is especially focused to provide a high number of transmitters to the end user while maintaining a consistent quality.

### Features

- IP69K rated safety class (flying leads)
- Pressure ranges up to 600 bar / 8702 PSI
- G1/4, 7/16–20 UNF process connection
- Output signal 4 ... 20 mA
- Rugged PBT housing
- Internal metal sleeve
- Stainless Steel connection
- Protect against incorrect polarity, short circuits and overvoltage
- M12 x 1, Deutsch 3-Pin and flying leads electrical connections

### Options

- 0 ... 10 V, 1 ... 5 V, 0.5 ... 4.5 V ratiometric available outputs on request
- 1/4 NPT process connection on request

### Order Codes



#### ① Type

Pressure Transmitter	<b>PT</b>
----------------------	-----------

#### ② Version

0 ... 16 bar / 0 ... 232 PSI	<b>B0016</b>
0 ... 25 bar / 0 ... 362 PSI	<b>B0025</b>
0 ... 40 bar / 0 ... 580 PSI	<b>B0040</b>
0 ... 60 bar / 0 ... 870 PSI	<b>B0060</b>
0 ... 100 bar / 0 ... 1450 PSI	<b>B0100</b>
0 ... 160 bar / 0 ... 2320 PSI	<b>B0160</b>
0 ... 250 bar / 0 ... 3625 PSI	<b>B0250</b>
0 ... 400 bar / 0 ... 5801 PSI	<b>B0400</b>
0 ... 500 bar / 0 ... 7251 PSI	<b>B0500</b>
0 ... 600 bar / 0 ... 8702 PSI	<b>B0600</b>

#### ③ Process Connection

G1/4 (standard option)	<b>B04</b>
1/4 NPT	<b>N04</b>
7/16–20 UNF (standard option)	<b>U04</b>

#### ④ Signal Output

4 ... 20 mA, 2-wire (standard option)	<b>420A</b>
0 ... 10 V, 3-wire	<b>010V</b>
1 ... 5 V, 3-wire	<b>15V</b>
0,5 ... 4,5 V, ratiometric	<b>0545V</b>

#### ⑤ Electrical Connection

M12 x 1 / 4-Pin	<b>M12</b>
Flying leads	<b>F</b>
Deutsch DT04-3P / 3-Pin	<b>D</b>



## Pressure Transmitters ▪ Type PT

**Technical Data**
**Materials**

- Body: Stainless Steel
- Connector: Fiberglass-reinforced Polybutylene Terephthalate (PBT)

**Signal Outputs and Maximum Load**

- Signal 4 ... 20 mA, 2-wire:  
Power supply 10 ... 36 V DC  
Ra ≤ ( UB-10 V) / 0,02A
- Signal 0 ... 10 V, 3-wire:  
Power supply 14 ... 36 V DC  
Ra > 5kΩ
- Signal 1 ... 5 V, 3-wire:  
Power supply 8 ... 36 V DC  
Ra > 2,5kΩ
- Signal 0,5 ... 4,5 V, ratiometric:  
Power supply 5 ... 30 V DC  
Ra > 4,5kΩ

**Response Time (10-90%)**

- ≤ 2 ms

**Isolation Voltage**

- 500 V DC

**Accuracy**

- ≤ ±0.5 % FS\*
- ≤ ±1.0 % FS\*  
\*(limit point calibration) (Includes linearity, hysteresis and repeatability)

**Repeatability**

- ≤ 0.2 % FS\*

**One Year Stability**

- ≤ 0.3 % FS\* (at reference conditions)

**Permissible Temperatures**

- Media\*: -40 ... +125 °C / -40 ... +257 °F
- Ambient\*: -40 ... +100 °C / -40 ... +212 °F
- Storage\*: -40 ... +120 °C / -40 ... +248 °F
- \* Also complies with EN 50178, Tab. 7,  
Operation (C) 4K4H, Storage (D) 1K4, Transport (E) 2K3
- Compensated temp. range: 0 ... +80 °C / +32 ... +176 °F

**Temperature Coefficients (TC) within Compensated Temperature Range**

- Mean TC of zero: ≤ 0,15 / 10k (special pressure ranges may have increased zero TC % FS\*)
- Mean TC of range: ≤ 0.15 / 10k % FS\*

**CE Conformity**

- 89/336/EWG interference emission and immunity see EN 61 326 interference emission limit class A and B 97/23/EG pressure equipment directive

**Shock Resistance**

- 500 g according to IEC 60068-2-27 (mechanical shock)

**Vibration Resistance**

- 20 g according to IEC 60068-2-6 (vibration under resonance)

**Wiring Protection**

- Protected against short circuiting signal+ to UB- / 0V
- Protected against reverse polarity except ratiometric output signals

**Weight**

- Approximately 59,53 g / 2.10 oz

**Electrical Connection**

- Flying leads, Deutsch DT04-3P, M12 x 1 / 4-Pin

**Process Connection**

- G1/4, 1/4 NPT, 7/16-20 UNF

**Protection Rating**

- Flying leads: IP 69K protection rating: Dust tight, for high-pressure, high-temperature wash down applications
- M 12 x 1: IP 67 protection rating: Dust tight and protected against powerful water jets; even immersion (up to 1 m / 3.28 ft) in water is possible under defined conditions of pressure and time
- Deutsch DT04-3P: IP 67 protection rating: Dust tight and protected against powerful water jets; even immersion (up to 1 m / 3.28 ft) in water is possible under defined conditions of pressure and time

\* FS = Full Scale

## Pressure Transmitters - Type PT

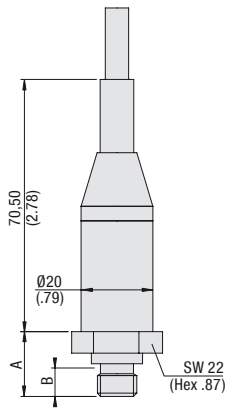

Flying Leads

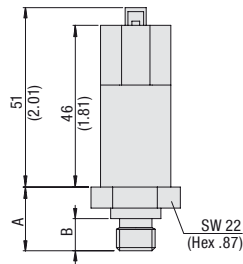

Deutsch DT04-3P / 3-Pin

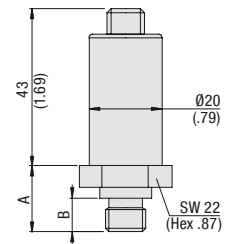

M12 x 1 / 4-Pin

### Dimensions

Version	A (mm/in)	B (mm/in)	Process Connection
B04	20,2	12,0	G1/4
	.80	.47	
N04	19,2	18,0	1/4 NPT
	.76	.71	
U04	17,6	9,14	7/16-20 UNF
	.69	.36	

### Pressure Ranges

Version	Pressure Range (bar/psi)	Maximum Pressure * (bar/psi)	Burst Pressure ** (bar/psi)
B0016	0 ... 16	32	160
	0 ... 232	464	2320
B0025	0 ... 25	50	250
	0 ... 362	725	3625
B0040	0 ... 40	80	400
	0 ... 580	1160	5801
B0060	0 ... 60	120	550
	0 ... 870	1740	7977
B0100	0 ... 100	200	800
	0 ... 1450	2900	11603
B0160	0 ... 160	320	1000
	0 ... 2320	4641	14503
B0250	0 ... 250	500	1200
	0 ... 3625	7251	17404
B0400	0 ... 400	800	1700
	0 ... 5801	11603	24656
B0500	0 ... 500	1200	2400
	0 ... 7251	17404	34809
B0600	0 ... 600	1200	2400
	0 ... 8702	17404	34809

Note:

\* Pressure applied up to the maximum rating will cause no permanent change in specifications but may lead to zero and span shifts.

\*\* Exceeding the burst pressure may result in destruction of the transmitter and possible loss of media.

## Pressure Transmitters ▪ Type PT

## Electrical Connections

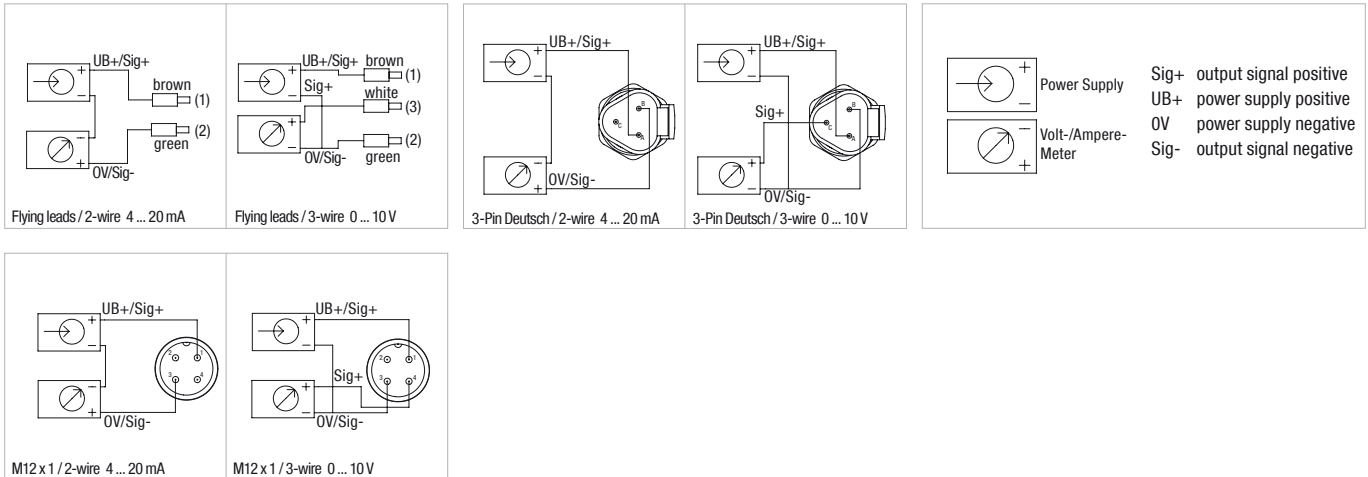

## Pressure Switch and Transmitter ▪ Type SPWF



### Product Description

The SPWF Pressure Switch and Transmitter features a LED display to provide continuous pressure monitoring and allows the operator to program the set points without having to pressurize the unit. The display can be rotated up to 330° to offer the best possible viewing position in any application.

### Features

- Stainless Steel construction
- LED display and easy programming of set points
- Two switching outputs
- Adjustment ranges of: -1 ... 700 bar / 14.5 ... 10152 PSI
- G1/4 and 1/4 NPT process connections
- LED display rotates up to 330°

### Options

- G1/2 and 1/2 NPT available process connections
- One switching output and one analog output
- Two switching outputs and one analog output

### Order Codes



#### ① Series and Type

Pressure Switch and Transmitter **SPWF**

#### ② Version

-1 ... 2 bar / -14.5 ... 29 PSI	<b>BN0002</b>
-1 ... 3 bar / -14.5 ... 43 PSI	<b>BN0003</b>
-1 ... 5 bar / -14.5 ... 72 PSI	<b>BN0005</b>
-1 ... 10 bar / -14.5 ... 145 PSI	<b>BN0010</b>
0 ... 2 bar / 0 ... 29 PSI	<b>B0002</b>
0 ... 5 bar / 0 ... 72 PSI	<b>B0005</b>
0 ... 10 bar / 0 ... 145 PSI	<b>B0010</b>
0 ... 20 bar / 0 ... 290 PSI	<b>B0020</b>
0 ... 50 bar / 0 ... 725 PSI (standard option)	<b>B0050</b>
0 ... 100 bar / 0 ... 1450 PSI (standard option)	<b>B0100</b>
0 ... 160 bar / 0 ... 2320 PSI (standard option)	<b>B0160</b>
0 ... 250 bar / 0 ... 3625 PSI (standard option)	<b>B0250</b>
0 ... 400 bar / 0 ... 5801 PSI (standard option)	<b>B0400</b>
0 ... 600 bar / 0 ... 8702 PSI (standard option)	<b>B0600</b>
0 ... 700 bar / 0 ... 10152 PSI	<b>B0700</b>

#### ③ Process Connection

G1/4 (standard option)	<b>B04</b>
G1/2	<b>B08</b>
1/4 NPT (standard option)	<b>N04</b>
1/2 NPT	<b>N08</b>

#### ④ Signal Output

Two switching outputs (standard option)	<b>1</b>
One switching output, one 4 ... 20 mA output	<b>2</b>
One switching output, one 0 ... 10 V output	<b>3</b>
Two switching outputs, one 4 ... 20 mA output	<b>4</b>

## Pressure Switch and Transmitter ■ Type SPWF

**Technical Data**
**Materials**

- Measuring Element: Stainless Steel for pressures above 103,42 bar / 1500 PSI, Ceramic for below 103,42 bar / 1500 PSI
- Housing: Stainless Steel
- Process Connection: Stainless Steel

**Supply Voltage**

- 12 ... 30 V DC, protection from reverse polarity and overload

**Power Consumption**

- ≤ 50 mA, without load current

**Switching Outputs**

- Switching function: Normally Closed (NC) or normally Open (NO)
- Damping (option): 0 ... 2000 ms
- Delay (option): 0 ... 99,99 s
- Power rating: 0,5 A max.

**Adjustment**

- Set point: 1 ... 100 % FS\*
- Reset point: 0 ... 99 % FS\*

**Analog Outputs**

- Standard: 4 ... 20 mA, 3-wire
- Option: 0 ... 10 V, 3-wire
- Scaling: 20 ... 100 % FS\*
- Load resistance: Current output <500, Voltage output >10 k
- Hysteresis: 0,3 % FS\*
- Response time: ≤2 ms within 10 ... 90 % of FS\*

**Accuracy**

- ±1 % FS\* +1 digit

**Repeatability**

- ≤0.2 % FS\*

**Electrical Connection**

- M12 x 1 / 4-Pin or M12 x 1 / 5-Pin

**Process Connection**

- G1/4, G1/2, 1/4 NPT, 1/2 NPT

**Permissible Temperatures**

- Media: -20 °C ... +80 °C / -4 °F ... +176 °F
- Ambient: -20 °C ... +70 °C / -4 °F ... +158 °F
- Storage: -30 °C ... +80 °C / -22 °F ... +176 °F
- Tk: 0.3 % per 10K

**Display**

- 7 segments, LED display, red, 7,6 mm / .30 in high
- 4 digits (-999 ... 9999)

**Load Capacity**

- Shock resistance: 50 g according to IEC 60068-2-27
- Vibration resistance: 10 g according to IEC 60068-2-6

**Weight**

- Approximately 0.30 kg / .70 lbs

**Protection Rating**

- IP 65 protection rating: Dust tight and protected against water jets

\* FS = Full Scale

## Pressure Switch and Transmitter ▀ Type SPWF

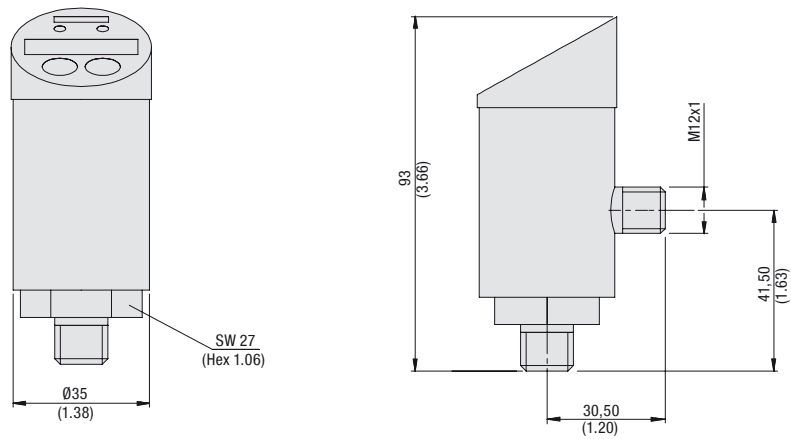

### Pressure Ranges

Version	Pressure Range (bar/psi)	Maximum Pressure (bar/psi)	Burst Pressure (bar/psi)
BN0002	-1 ... 2	5	6
	-14.5 ... 29	72	87
BN0003	-1 ... 3	5	6
	-14.5 ... 43	72	87
BN0005	-1 ... 5	10	12
	-14.5 ... 72	145	174
BN0010	-1 ... 10	20	25
	-14.5 ... 145	290	362
B0002	0 ... 2	5	6
	0 ... 29	72	87
B0005	0 ... 5	10	12
	0 ... 72	145	174
B0010	0 ... 10	20	25
	0 ... 145	290	362
B0020	0 ... 20	40	50
	0 ... 290	580	725
B0050*	0 ... 50	100	120
	0 ... 725	1450	1740
B0100*	0 ... 100	200	800
	0 ... 1450	2900	11603
B0160*	0 ... 160	320	1000
	0 ... 2320	4641	14503
B0250*	0 ... 250	500	1200
	0 ... 3625	7251	17404
B0400*	0 ... 400	800	1700
	0 ... 5801	11603	24656
B0600*	0 ... 600	1200	2400
	0 ... 8702	17404	34809
B0700	0 ... 700	1200	2400
	0 ... 10152	17404	34809

Note:

\* Standard option

**Pressure Switch and Transmitter ▪ Type SPWF**

**Electrical Connections**

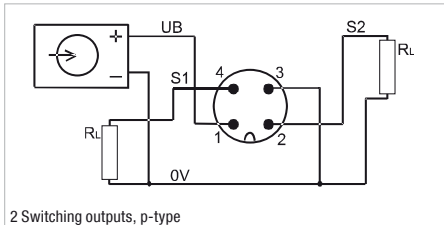

2 Switching outputs, p-type

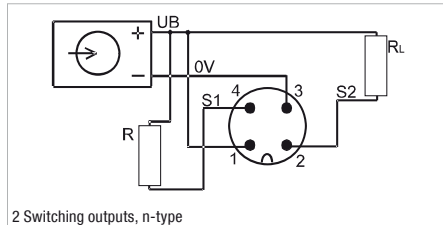

2 Switching outputs, n-type

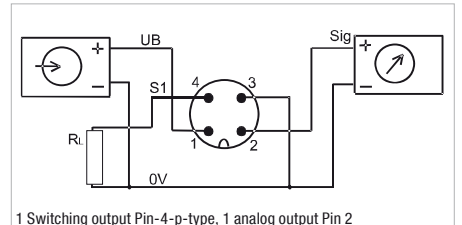

1 Switching output Pin-4-p-type, 1 analog output Pin 2

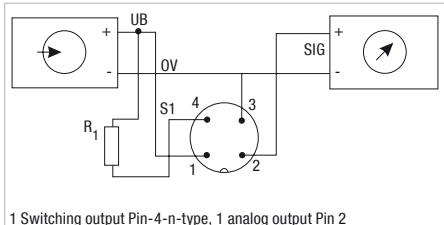

1 Switching output Pin-4-n-type, 1 analog output Pin 2

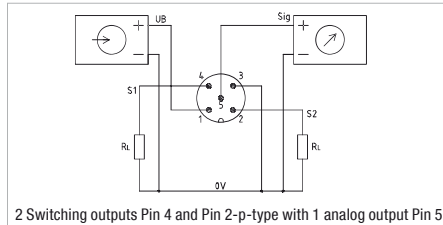

2 Switching outputs Pin 4 and Pin 2-p-type with 1 analog output Pin 5

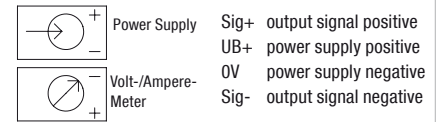

## Temperature Switch and Transmitter - Type STWE



### Product Description

The STWE Temperature Switch and Transmitter features LED display to provide continuous temperature monitoring and allows the operator to easily adjust set and reset points by using the two programming buttons located on the display face on the unit. The display face can be rotated up to 330° to offer the best possible viewing position in any application.

### Features

- Stainless Steel construction
- LED display and easy programming of set points
- Two switching outputs
- Temperature range: -50 °C ... +125 °C / -58 °F ... +257 °F
- G1/4 and 1/4 NPT process connections
- Different stem lengths
- LED display rotates up to 330°

### Options

- G1/2 and 1/2 NPT available process connections
- Temperature range available from -200 °C ... +600 °C / -328 °F ... +1112 °F
- One switching output and one analog output

### Order Codes

**STWE - CN0125 - B04 - 1 - 100**

①

②

③

④

⑤

#### ① Series and Type

Temperature Switch and Transmitter	<b>STWE</b>
------------------------------------	-------------

#### ② Temperature Ranges

-50 ... +125 °C / -58 ... +257 °F (standard option)	<b>CN0125</b>
-50 ... +200 °C / -58 ... +392 °F	<b>CN0200</b>
-200 ... +600 °C / -328 ... +1112 °F	<b>CN0600</b>
0 ... +400 °C / +32 ... +752 °F	<b>C0400</b>
0 ... +600 °C / +32 ... +1112 °F (standard option)	<b>C0600</b>

#### ③ Process Connection

G1/4 (standard option)	<b>B04</b>
G1/2	<b>B08</b>
1/4 NPT (standard option)	<b>N04</b>
1/2 NPT	<b>N08</b>

#### ④ Signal Output

Two switching outputs (standard option)	<b>1</b>
One switching output, one 4 ... 20 mA Output	<b>2</b>

#### ⑤ Stem Lengths

50 mm / 1.97 in	<b>50</b>
75 mm / 2.95 in	<b>75</b>
100 mm / 3.94 in	<b>100</b>
160 mm / 6.30 in	<b>160</b>
200 mm / 7.87 in	<b>200</b>
300 mm / 11.81 in	<b>300</b>



## Temperature Switch and Transmitter ■ Type STWE

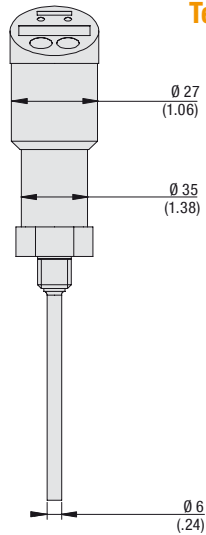
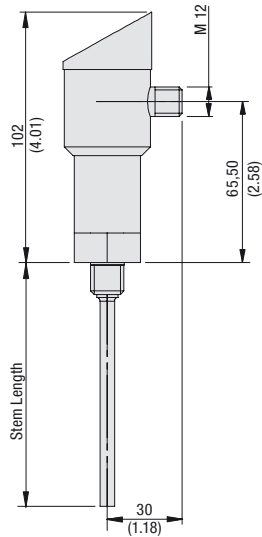

## Technical Data

**Materials**

- Housing: Stainless Steel
- Process connection: Stainless Steel

**Supply Voltage**

- 12...30 V DC, protection from reverse polarity and overload

**Power Consumption**

- ≤50 mA, without load current

**Switching Outputs**

- Switching function: Normally open (NO) or normally closed (NC)
- Power rating: 100 mA per switch output

**Adjustment**

- Setpoint 0.1 ° steps within temperature range
- Resetpoint 0.1 ° steps within temperature range up to (Setpoint -0.1°)

**Analog Output**

- Signal 4 ... 20 mA, 3-wire
- Load resistance  $R_a = U_s - 7 \text{ V} / 0.022 \text{ A}$

**Accuracy**

- Accuracy of PT100 sensing element ±0.1 % of temperature range

**Repeatability**

- 0.05 %

**Stem Length and Working Pressure (standard option)**

- Ø 6 x 50 mm / .24 x 1.97 in stem length, up to 40 bar / 580 PSI
- Additional stem lengths available upon request

**Process Connection**

- G1/4, G1/2, 1/4 NPT, 1/2 NPT

**Electrical Connection**

- M12 x 1 / 4-Pin

**Permissible Temperatures**

- Ambient: -30 °C ... +80 °C / -22 °F ... +176 °F
- Storage: -25 °C ... +70 °C / -13 °F ... +158 °F
- Tk: 0,1 % of measuring range per 10K

**EMC to IEC / EN 61326**

- IEC 61000/4/2 ESD: B
- IEC 61000/4/3 HF Radiated: A
- IEC 61000/4/4 Burst: A
- IEC 61000/4/5 Surge: A
- IEC 61000/4/6 HF Mains Borne: A

**EMC to IEC / EN 61326**

- Approx 0.30 kg / .70 lbs (dependent on stem length)

**Protection Rating**

- IP 65 protection rating: Dust tight and protected against water jets

## Electrical Connections

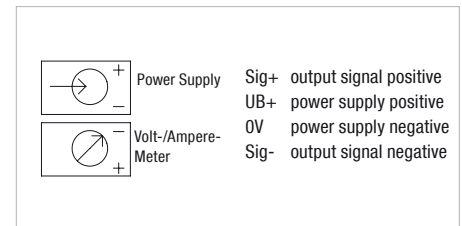
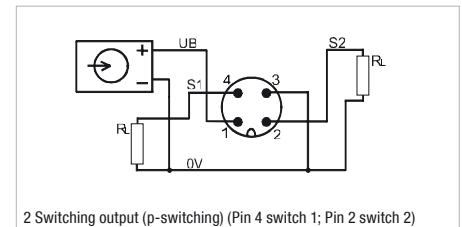
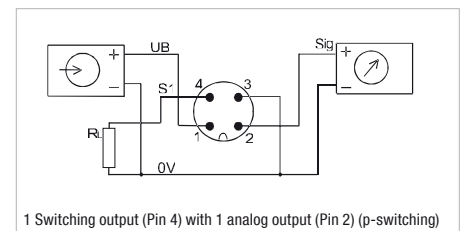

## Temperature Transmitter ▪ Type STC



### Product Description

The STC Temperature Transmitters is designed for process temperature measurement in low pressures. This unit features an all stainless steel construction up to 300 mm / 11.81 in stem length with G1/4 and 1/4 NPT process connection and a 4 ... 20 mA output. The user can select the exact temperature range they require at time of order.

### Features

- Stainless Steel construction
- 4 ... 20 mA output
- 0 °C ... 50 °C, 0 °C ... 100 °C and 0 °C ... 120 °C measuring ranges available
- L-Plug DIN EN 175301-803A (DIN 43650-A) electrical connection
- G1/4 or 1/4 NPT process connection
- 50 and 100 mm stem lengths

### Options

- 0 ... 10 V available output
- M12 x 1 electrical connection available
- G1/2 and 1/2 NPT available process connections
- 75, 160, 200 and 300 mm stem lengths available
- Available with an adjustable compression ring version for variable stem length

### Order Codes

<b>STC</b>	-	<b>C0050</b>	-	<b>B04</b>	-	<b>420A</b>	-	<b>1</b>	-	<b>50</b>	<b>F</b>
①		②		③		④		⑤		⑥	⑦

#### ① Series and Type

Temperature Transmitter	<b>STC</b>
-------------------------	------------

#### ② Temperature Ranges

0 ... +50 °C / +32 ... +122 °F	<b>C0050</b>
0 ... +100 °C / +32 ... +212 °F	<b>C0100</b>
0 ... +120 °C / +32 ... +248 °F	<b>C0120</b>

Note: Please consult STAUFF for alternative temperature ranges.

#### ③ Process Connection

G1/4	<b>B04</b>
G1/2 *	<b>B08</b>
1/4 NPT *	<b>N04</b>
1/2 NPT *	<b>N08</b>

\* Threads only available with adjustable compression ring fitting.

#### ④ Signal Output

4 ... 20 mA (standard option)	<b>420A</b>
0 ... 10 V	<b>010V</b>

#### ⑤ Electrical Connection

L-Plug DIN EN 175301-803A (DIN 43650-A) (standard option)	<b>1</b>
M12 x 1 / 4-Pin	<b>2</b>

#### ⑥ Stem Lengths

50 mm / 1.97 in (standard option) *	<b>50</b>
75 mm / 2.95 in *	<b>75</b>
100 mm / 3.94 in (standard option)	<b>100</b>
160 mm / 6.30 in	<b>160</b>
200 mm / 7.87 in	<b>200</b>
300 mm / 11.81 in	<b>300</b>

\* Length only available with a fixed thread.

#### ⑦ Style

Fixed thread (standard option)	<b>F</b>
Adjustable compression fitting	<b>A</b>

## Temperature Transmitter ■ Type STC

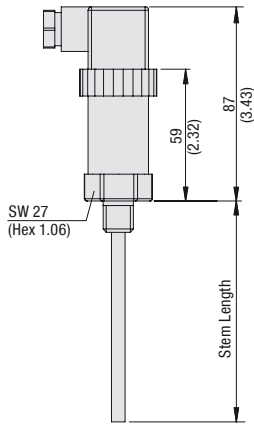

L-Plug DIN 175301-803A (DIN 43650-A)

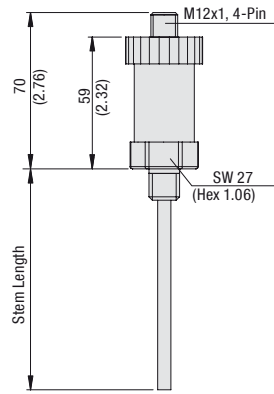

M12 x 1 / 4-Pin

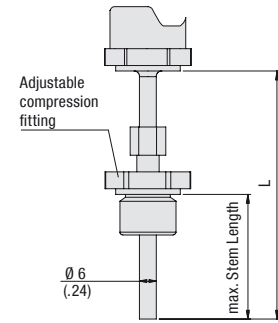

Adjustable Compression Fitting

## Technical Data

## Materials

- Housing: Stainless Steel 1.4571 (316 Ti)
- Process connection: Stainless Steel 1.4571 (316 Ti)
- Stem: Stainless Steel 1.4571 (316 Ti)

## Signal Outputs and Supply Voltage

- 4 ... 20 mA, 2-wire, 10 ... 30 V DC, ripple <10%
- 0 ... 10 V, 3-wire, 12 ... 30 V DC, ripple <10%

## Error Signals

- 23 mA sensor burnout
- 3.3 mA sensor short circuit

## Accuracy

- $\leq \pm 5\%$  of FS\*

## Temperature Range

- $-50\text{ }^{\circ}\text{C} \dots +200\text{ }^{\circ}\text{C} / -58\text{ }^{\circ}\text{F} \dots +392\text{ }^{\circ}\text{F}$

## Measuring Range

- Minimum range: 50 K
- Maximum range: 250 K

## Process Connection

- G1/4, G1/2, 1/4 NPT, 1/2 NPT

## Electrical Connection

- L-Plug according to DIN EN 175301-803A (DIN 43650-A)
- M12 x 1 / 4-Pin

## Stem Length and Pressure Ranges

- 50 ... 500 mm / 1.97 x 19.67 in: up to 40 bar / 580 PSI (Pressure ranges refer to static pressure.)

## Permissible Temperatures

- Ambient: max.  $+85\text{ }^{\circ}\text{C} / +185\text{ }^{\circ}\text{F}$
- Storage:  $-40\text{ }^{\circ}\text{C} \dots +85\text{ }^{\circ}\text{C} / -40\text{ }^{\circ}\text{F} \dots +185\text{ }^{\circ}\text{F}$

## EMC-Resistance

- Emitted interference acc. to DIN EN 61326
- Breakdown effect acc. to DIN EN 61326

## Weight

- Approx. 0.14 kg / .31 lbs (dependant on stem length)

## Protection Rating

- L-Plug connection: IP 65 protection rating: Dust tight and protected against water jets
- M12 x 1 connection: IP 67 protection rating: Dust tight and protected against powerful water jets; even immersion (up to 1 m / 3.28 ft) in water is possible under defined conditions of pressure and time

## Wiring Scheme

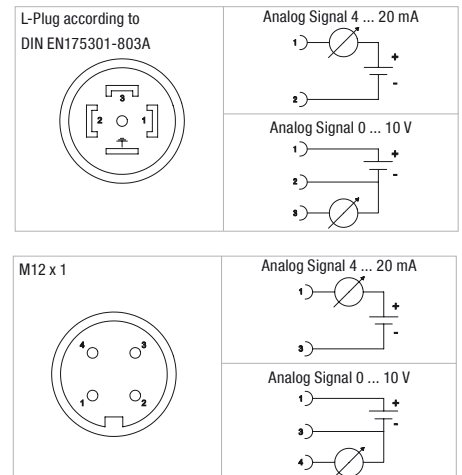

\* FS = Full Scale

Dimensional drawings: All dimensions in mm (in).

## Temperature Switch ▀ Type STW

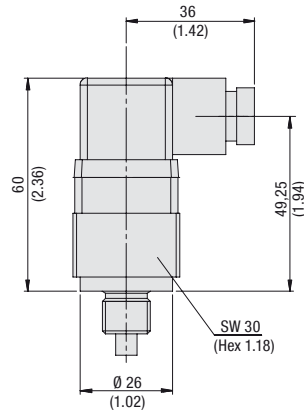

### Wiring Scheme

Wiring diagram normally open

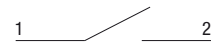

Wiring diagram normally closed



### Product Description

The STW mechanical Temperature Switch is available in a variety of temperature ranges. This unit features a bimetallic fixed set point. The electrical connector of the SPW is designed to rotate in order to face the cable clamp into whatever position desired after installation.

### Features

- Normally open and normally closed switching function
- Fixed set points from +60 °C ... +80 °C / +140 °F ... +176 °F
- G1/4 and 1/4 NPT process connections
- Brass body

### Options

- Fixed set points from +30 °C ... +105 °C / +86 °F ... +221 °F
- G1/2 and 1/8 NPT process connections

### Technical Data

#### Materials

- Body: Brass
- Connector: Polyamide

#### Signal Outputs

- Normally open (NO) or normally closed (NC)

#### Maximal Switching Values

- Maximal voltage: 250 V AC
- Maximal current: 10 A at 240 V AC  
5 A at 24 V AC  
10 A at 12 V AC

#### Accuracy

- ±5 °C / ±9 °F

#### Maximum Ratings

- Temperature: +130 °C / +266 °F
- Pressure: 150 bar / 2175 PSI

#### Electrical Connection

- DIN EN 175301-803 form A-PG09 (DIN 43650-A)

#### Process Connection

- G1/4, G1/2, 1/8 NPT, 1/4 NPT

#### Protection Rating

- IP 65 protection rating: Dust tight and protected against water jets

### Order Codes

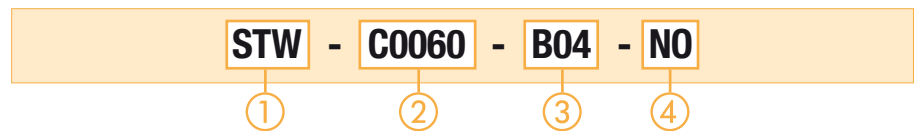

#### ① Series and Type

Pressure Switch **STW**

#### ② Temperature Ranges (Fixed Set Point)

+30 °C / +86 °F	<b>C0030</b>
+40 °C / +104 °F	<b>C0040</b>
+50 °C / +122 °F	<b>C0050</b>
+60 °C / +140 °F (standard option)	<b>C0060</b>
+70 °C / +158 °F (standard option)	<b>C0070</b>
+80 °C / +176 °F (standard option)	<b>C0080</b>
+90 °C / +194 °F	<b>C0090</b>
+100 °C / +212 °F	<b>C0100</b>
+105 °C / +221 °F	<b>C0105</b>

#### ③ Process Connection

G1/4 (standard option)	<b>B04</b>
G1/2	<b>B08</b>
1/8 NPT	<b>N02</b>
1/4 NPT (standard option)	<b>N04</b>

#### ④ Contacts

Normally open (standard option)	<b>NO</b>
Normally closed	<b>NC</b>

## Flowtell Inline Flow Meter - Type SFF

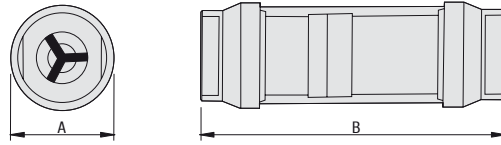

## Order Codes

**SFF - L00005 - B08**

①

②

③

## ① Series and Type

 Flowtell Inline Flow Meter **SFF**

## ② Flow Ranges

2 ... 18 l/min / 0.5 ... 5 US GPM	<b>L00005</b>
12 ... 113 l/min / 3 ... 30 US GPM	<b>L00030</b>
31 ... 283 l/min / 8 ... 75 US GPM	<b>L00075</b>

## ③ Process Connection

G1/2 (only L00005)	<b>B08</b>
G3/4 (only L00030)	<b>B09</b>
G1-1/4 (only L00075)	<b>B20</b>
1/2 NPT (only L00005)	<b>N08</b>
3/4 NPT (only L00030)	<b>N09</b>
1-1/4 NPT (only L00075)	<b>N20</b>

## Product Description

The STAUFF Flowtell Inline Flow Meter is ideal for monitor case drain flows, pump performance and media flows through hydraulic circuits and sub-circuits. It allows the designer to install it in any orientation (horizontal, vertical or inverted) and is weather-tight for use outdoors and/or on systems where wash downs are required. It is also a reliable service tool that provides years of maintenance-free performance. Flows can be measured up to a value of 283 l/min / 75 GPM.

## Features

- G1/2, G3/4, G1-1/4, 1/2 NPT, 3/4 NPT and 1-1/4 NPT process connection
- Flow ranges up to 283 l/min / 75 US GPM

## Options

- Other process connection on request

## Technical Data

**Materials**

- Aluminium end caps
- Polycarbonate Windows Tube
- NBR (Buna-N®) and Teflon sealings
- Suitable for Mineral-Based Hydraulic Fluid

**Accuracy**

- ±2.5 % of full scale in mid-third of flow range
- ±4.0 % over entire flow range

**Repeatability**

- ±1 % of full sale

**Max. Operating Pressure**

- 240 bar / 3500 PSI

**Max. Operating Temperature**

- +116 °C / +240 °F

## Dimensions

Codes	A (mm/in)	B (mm/in)
SFF-L00005-B08	48	167
	1.88	6.56
SFF-L00030-B09	60	182
	2.38	7.16
SFF-L00075-B20	90	258
	3.5	10.13
SFF-L00005-N08	48	167
	1.88	6.56
SFF-L00030-N09	60	182
	2.38	7.16
SFF-L00075-N20	90	258
	3.5	10.13



## Flow Indicators - Types SDM / SDM-K

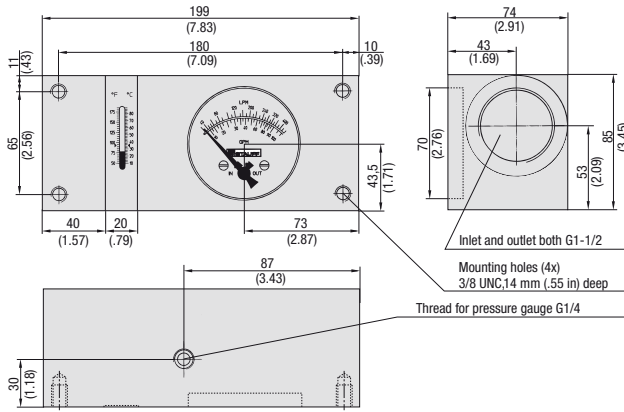

Dimensions SDM-1500

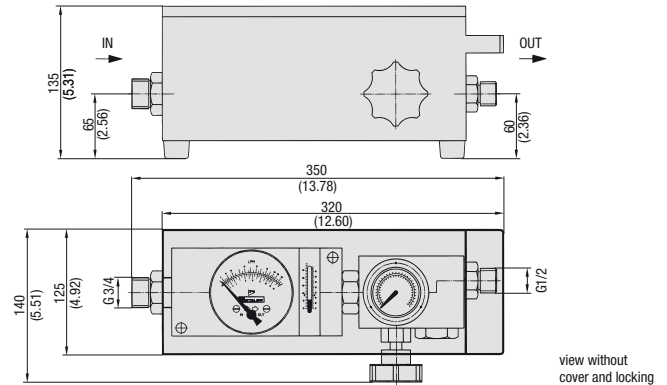

Dimensions SDM-K-750

## Technical Data

Order Codes	Max. Working Pressure (bar/PSI)	Flow Range (l/min/US GPM) Aluminum Units	Flow Range Bronze Units (only SDM) *	Weight (kg/lbs)	Connection
SDM-750-A-016-T	420 6091	2 - 16 0.5 - 4	- -	1,36 3.0	G3/4
SDM-750-A-030-T	420 6091	2 - 30 0.5 - 8	- -	1,36 3.0	G3/4
SDM-750-A-060-T	420 6091	2 - 60 0.5 - 16	- -	1,36 3.0	G3/4
SDM-750-A-120-T	420 6091	4 - 120 1 - 32	- -	1,36 3.0	G3/4
SDM-750-A-180-T	420 6091	10 - 180 4 - 48	- -	1,36 3.0	G3/4
SDM-750-B-030-T	420 6091	- -	2 - 30 l/min in oil 2 - 30 l/min in water	4,25 9.34	G3/4
SDM-750-B-060-T	420 6091	- -	3 - 60 l/min in oil 3 - 70 l/min in water	3,80 8.40	G3/4
SDM-750-B-120-T	420 6091	- -	4 - 120 l/min in oil 4 - 140 l/min in water	4,25 9.34	G3/4
SDM-1500-A-200-T	280 4061	10 - 200 5 - 50	- -	3,0 6.61	G1-1/2
SDM-1500-A-300-T	350 5075	20 - 300 4 - 80	- -	3,0 6.61	G1-1/2
SDM-1500-A-400-T	280 4061	20 - 400 5 - 100	- -	3,0 6.61	G1-1/2
SDM-1500-B-200-T	280 4061	- -	10 - 200 l/min in oil 10 - 200 l/min in water	8,0 17.64	G1-1/2
SDM-1500-B-400-T	280 4061	- -	20 - 400 l/min in oil 20 - 400 l/min in water	8,0 17.64	G1-1/2
SDMK-750-A-030-T	420 6091	2 - 30 0.5 - 8	- -	4,5 9.92	G3/4 + G1/2
SDMK-750-A-060-T	420 6091	2 - 60 0.5 - 16	- -	4,5 9.92	G3/4 + G1/2
SDMK-750-A-120-T	420 6091	4 - 120 1 - 32	- -	4,5 9.92	G3/4 + G1/2
SDMK-750-A-180-T	420 6091	10 - 180 4 - 48	- -	4,5 9.92	G3/4 + G1/2

## Flow Curves

Curves refer to kinematic viscosity of 28cSt.

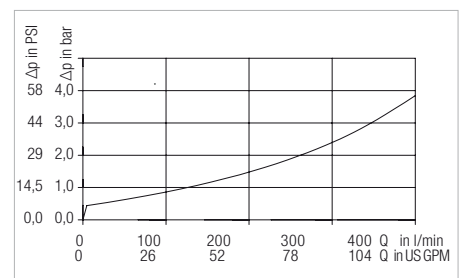
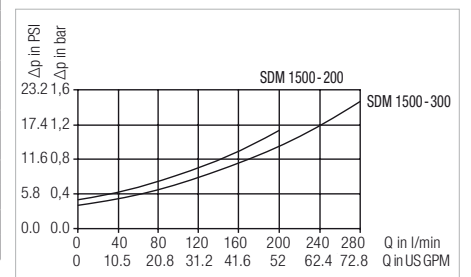
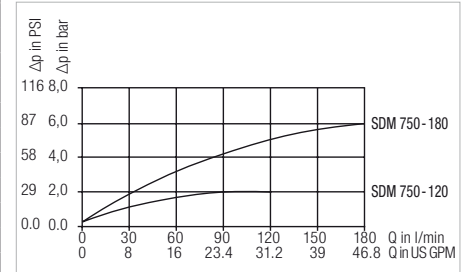
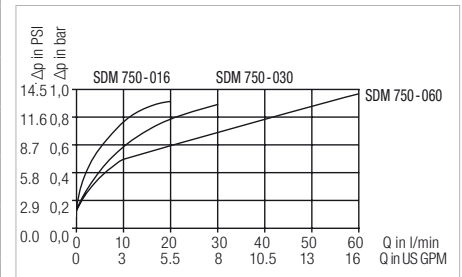

\* The Bronze units have a scale for water and oil – both in l/min.  
Dimensional drawings: All dimensions in mm (in).

## Flow Monitoring System ▀ Types SGF



### Product Description

The STAUFF SGF positive displacement Flow Meter offers a comprehensive solution for high accuracy and high pressure flow monitoring. The units are available for flow ranges from 0,002 L/min to 525 L/min / 0.0005 to 138 GPM and are suitable for pressures up to 450 bar / 6500 PSI. It is possible to integrate the units direct into the hydraulic circuit.

Furthermore a special digital display to visualize the flow is available.

Media specific models are available for applications such as: Hydraulic test stand, Grease, Ink, Lubrication Systems, Diesel Fuel, Kerosene and Brake Fluid.

### Technical Data

#### Materials

- Body: EN-GJS-400-15 (EN 1563) / Stainless Steel 1.4305
- Bearings: Bronze, Carbon, Steel
- Sealings: FPM (Viton®), NBR (Buna-N®), PTFE, EPDM

#### Accuracy

- ± 0.3 % of measured value at 20 cSt

#### Repeatability

- ± 0.05 % of measured value at 20 cSt

#### Power Supply

- 10 ... 28 V DC

#### Max. Operating Pressure

- Cast Iron housing: 315 bar / 4568 PSI
- Stainless Steel housing: 450 bar / 6526 PSI

#### Medium Temperature

- -40 °C ... +120 °C / -40 °F ... +248 °F

#### Viscosity Range

- Up to 100000 cSt (depends on type)

### Order Codes

SGF - 0.04 - M - C - 1 - V - X

1    2    3    4    5    6    7

#### ① Series and Type

Flow Monitoring System **SGF**

#### ② Version

0,002 ... 2 l/min / 0.0005 ... 0.53 US GPM	<b>0.02</b>
0,004 ... 4 l/min / 0.0011 ... 1.06 US GPM	<b>0.04</b>
0,01 ... 10 l/min / 0.0026 ... 2.64 US GPM	<b>0.1</b>
0,02 ... 18 l/min / 0.0053 ... 4.76 US GPM	<b>0.2</b>
0,03 ... 40 l/min / 0.0079 ... 10.57 US GPM	<b>0.4</b>
0,05 ... 80 l/min / 0.0132 ... 21.13 US GPM	<b>1</b>
0,1 ... 120 l/min / 0.0264 ... 31.70 US GPM	<b>2</b>
1,0 ... 250 l/min / 0.2642 ... 66.00 US GPM	<b>4</b>

#### ③ Connection Type

Manifold plate mount **M**  
Side port connection **R**

#### ④ Material

Cast Iron **C**  
Stainless Steel 1.4305 **S**

#### ⑤ Bearing Type

Ball bearing	<b>1</b>
Spindle - bearing	<b>2</b>
Bronze - plain bearing	<b>3</b>
Carbon - plain bearing	<b>4</b>
Steel - plain bearing	<b>5</b>

#### ⑥ Sealings

FPM (Viton®) (standard option)	<b>V</b>
NBR (Buna-N®)	<b>B</b>
PTFE	<b>T</b>
EPDM	<b>E</b>

#### ⑦ Special Options

Contact STAUFF for details

Contact STAUFF for full product specifications.

### Available Ranges

Version	Geometric Tooth Volume cm <sup>3</sup>	Measuring Range (l/min/GPM)	K-Factor (Imp/Liter/Imp/Gal)
<b>0.02</b>	0,02	0,002 ... 2	50000
		0,005 ... 0.53	189272
<b>0.04</b>	0,04	0,004 ... 4	25000
		0,0011 ... 1.06	94636
<b>0.1</b>	0,1	0,01 ... 10	10000
		0,0026 ... 2.64	37854.4
<b>0.2</b>	0,2	0,02 ... 18	5000
		0,0053 ... 4.76	18927.2
<b>0.4</b>	0,4	0,03 ... 40	2500
		0,0079 ... 10.57	9463.6
<b>1</b>	1	0,05 ... 80	1000
		0,0132 ... 21.13	3785.44
<b>2</b>	2	0,1 ... 120	500
		0,0264 ... 31.70	1892.72
<b>4</b>	4	1 ... 250	250
		0,2642 ... 66.00	946.36



## Flow Monitoring System ■ Type SGFE



## Order Codes

**① Series and Type**

 Flow Monitoring System **SGFE**
**② Version**

0,05 ... 4 l/min / 0.013 ... 1.06 US GPM	<b>0.04</b>
0,1 ... 10 l/min / 0.026 ... 2.64 US GPM	<b>0.1</b>
0,2 ... 30 l/min / 0.053 ... 7.93 US GPM	<b>0.4</b>
0,5 ... 70 l/min / 0.132 ... 18.49 US GPM	<b>2</b>
3,0 ... 150 l/min / 0.79 ... 39.63 US GPM	<b>4</b>

**③ Connection Type**

Manifold plate mount	<b>M</b>
Side port connection	<b>R</b>

**④ Bearing Type**

Stainless Steel - ball bearing	<b>1</b>
Bronze - sleeve bearing	<b>2</b>
DU - sleeve bearing	<b>3</b>

**⑤ Pulse Output**

NPN	<b>N</b>
PNP	<b>P</b>

**⑥ Sealings**

FPM (Viton®) (standard option)	<b>V</b>
NBR (Buna-N®)	<b>B</b>
PTFE	<b>T</b>
EPDM	<b>E</b>

**⑦ Special Options**

Contact STAUFF for details

**Contact STAUFF for full product specifications.**

## Product Description

Based upon the same positive displacement gear principle as the STAUFF SGF series, the SGFE Aluminum Ecoflow Flow Meter is an economical alternative for applications that require lower accuracy, temperature, and pressure.

## Features

- In-line or subplate mounting for ease of installation
- An integrated pick up with PNP or NPN switching output produces one impulse per tooth volume.

## Options

- LCD flow display with analog output and set limit switches mounted directly to the flow meter

## Technical Data

**Materials**

- Body: Aluminium
- Bearings: Stainless Steel, Bronze, DU
- Sealings: FPM (Viton®), NBR (Buna-N®), PTFE, EPDM

**Accuracy**

- ± 2 % of measured value at 20 cSt

**Power Supply**

- 10 ... 30 V DC

**Max. Operating Pressure**

- 200 bar / 2900 PSI

**Medium Temperature**

- 0 °C ... +80 °C / 32 °F ... +176 °F

**Viscosity Range**

- Up to 100000 cSt (depends on type)

## Available Ranges

Version	Geometric Tooth Volume cm <sup>3</sup>	Measuring Range (l/min / gPM)	K-Factor (lmp/Liter / lmp/Gal)
<b>0.04</b>	0,04	0,05 ... 4	25000
		0.013 ... 1.06	94636
<b>0.1</b>	0,1	0,1 ... 10	10000
		0.026 ... 2.64	37854.40
<b>0.4</b>	0,4	0,2 ... 30	2500
		0.053 ... 7.93	9463.60
<b>2</b>	2,0	0,5 ... 70	500
		0.13 ... 18.49	1892.72
<b>4</b>	4,0	3,0 ... 150	250
		0.79 ... 39.63	946.36

## Order Code

**STD-1**

## Functions

- The STD1 processes incremental input signals from STAUFF volume counters and other sensors
- The input signal are filtered in the unit, then interpreted and then converted into values of flow rate
- The user may choose to have either flow rate or volume displayed
- One analog output is available for further external processing

## Product Description

- Programmable microprocessor
- Flow rate and volume measurement
- Selectable time basis (sec, min, hrs)
- Selectable units for display
- Selected analog outputs include ±10 V, 0 ... 10 V, ±20 mA and 4 ... 20 mA
- Power supply voltage options include 230 V AC, 115 V AC, 24 V DC and 12 V DC
- Enclosure dimensions to DIN standard (96 x 48 x 120 mm / 3.78 x 1.89 x 4.72 in)
- Other display type units are available, please contact STAUFF for details

## Flow Rate Measuring Display ■ Type STD 1



